

K. Zuber, TU Dresden

K. Zuber

New experimental attempts to tackle lepton number and flavor violation

DESY Zeuthen, 24.1.2018

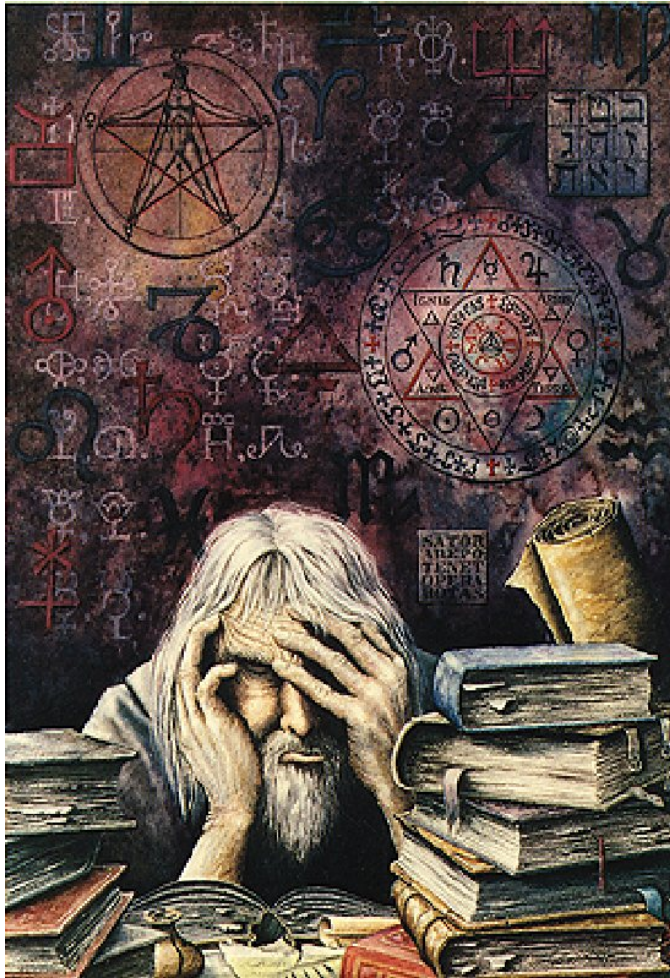

- Introduction
- Why double beta decay?
- The physics
- General issues
- GERDA and LEGEND

- What about charged lepton flavour violation?
- The COMET experiment

- Summary

Neutrinos in the Standard Model are massless particles

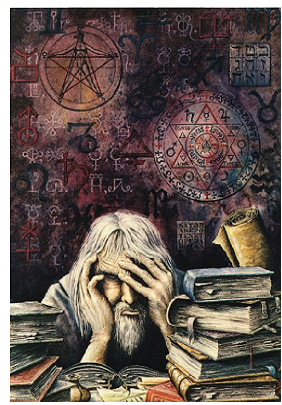
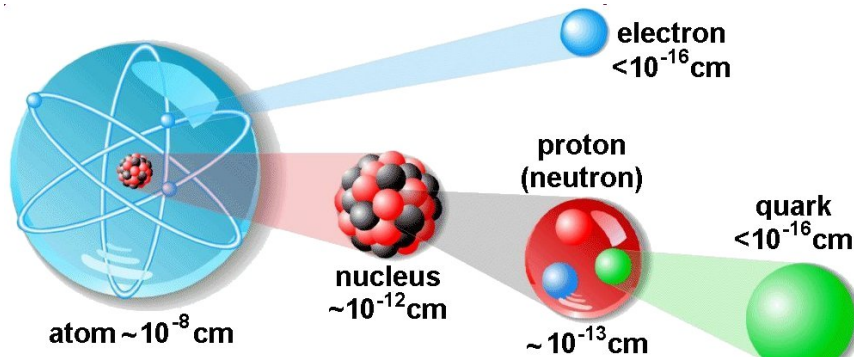

Leptons
 Lepton number

MATTER CONSTITUENTS: FERMIONS
 QUARKS
 LEPTONS

THREE GENERATIONS OF MATTER			CHARGE:	
I	II	III		
2.75 UP	1300 CHARM	178000 TOP	$-\frac{2}{3}$	91188 Z^0
6 DOWN	110 STRANGE	4500 BOTTOM	$-\frac{1}{3}$	80430 W^+/W^-
0.511 ELECTRON	105.7 MUON	1777 TAU	-1	$< 10^{-23}$ PHOTON
$< 3 \cdot 10^{-6}$ NEUTRINO	< 0.19 NEUTRINO	< 18.2 NEUTRINO	0	theory: 0 GLUON

FORCE CARRIERS: BOSONS

ALL MASSES IN MEV;
 ANIMAL MASSES
 SCALE WITH
 PARTICLE MASSES

The Standard Model
 fundamental particle zoo

As far as we know total lepton number is conserved

intrinsic **particle-antiparticle symmetry** of neutrinos?

Dirac neutrino

4 ν states
lepton number
conservation $\Delta L = 0$
neutrino \neq antineutrino

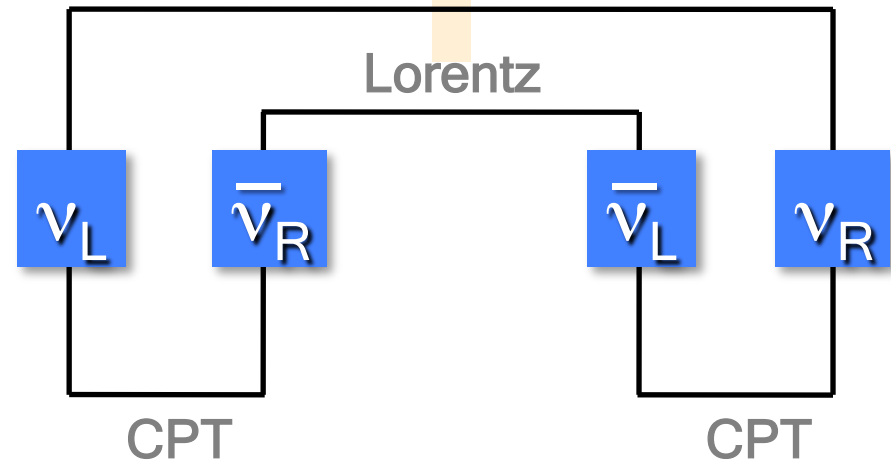

Majorana neutrino

2 ν states
lepton number
violation $\Delta L = 2$

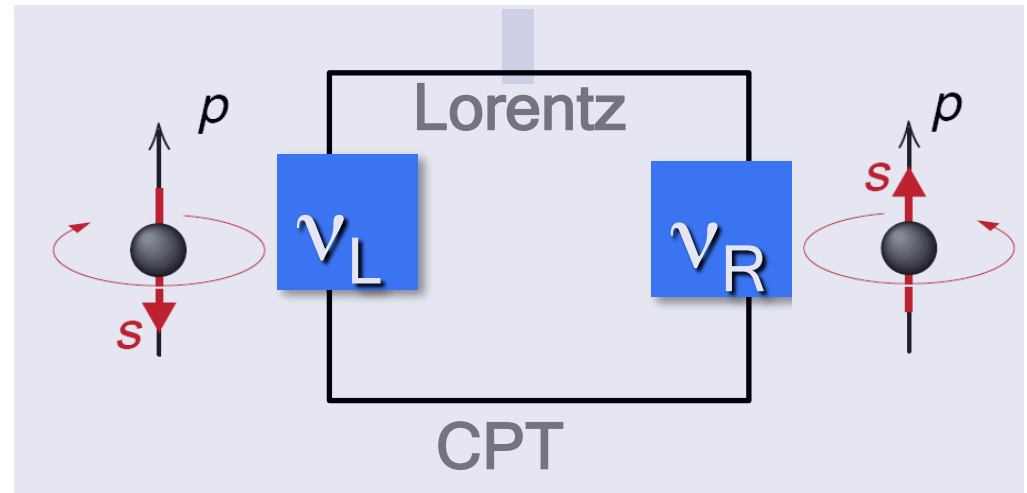

ν^D and ν^M only distinguishable
if $m_\nu \neq 0$

- $(A,Z) \rightarrow (A,Z+2) + 2 e^- + 2 \bar{\nu}_e$ $2\nu\beta\beta$
- $(A,Z) \rightarrow (A,Z+2) + 2 e^-$ $0\nu\beta\beta$

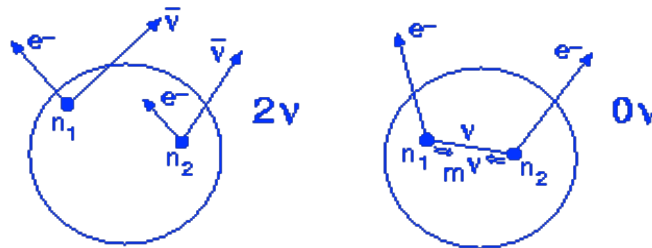

Unique process to measure character of neutrino



The smaller the neutrino mass the longer the half-life

Neutrino mass measurement via half-life measurement

Requires half-life measurements well beyond 10^{20} yrs!!!!

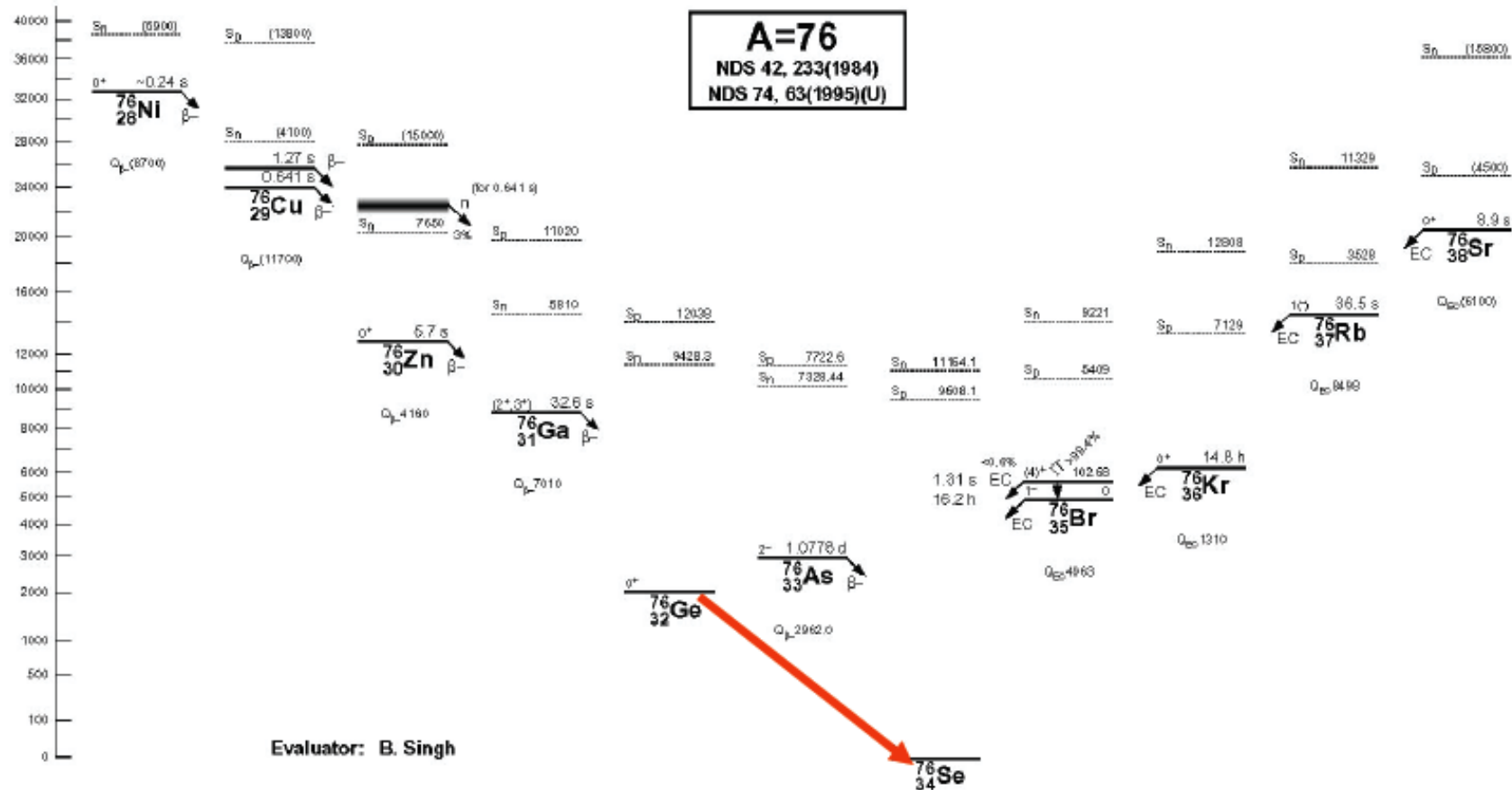

Only 35 isotopes in nature are able to do that!

Any $\Delta L=2$ process can contribute to $0\nu\beta\beta$

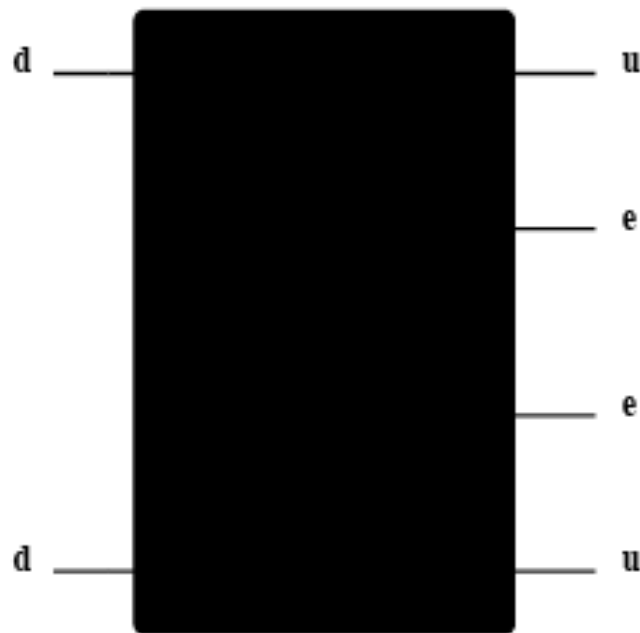

R_p violating SUSY

V+A interactions

Extra dimensions (KK- states)

Leptoquarks

Double charged Higgs bosons

Compositeness

Heavy Majorana neutrino exchange

Light Majorana neutrino exchange

...

$$1 / T_{1/2} = PS * NME^2 * \epsilon^2$$



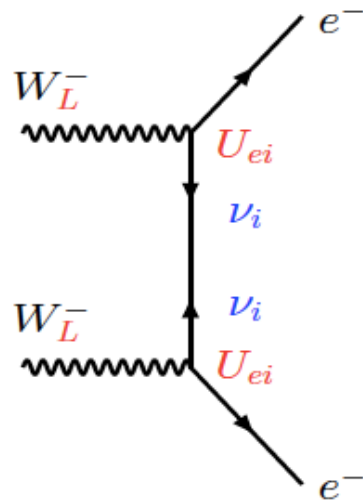

$$\varepsilon \equiv \langle m_\nu \rangle = \left| \sum_i U_{ei}^2 m_{\nu_i} \right|$$

$$1 / T_{1/2} = PS * NME^2 * (\langle m_\nu \rangle / m_e)^2$$

Schechter and Valle 1982:

Independent of mechanism for neutrinoless DBD
Majorana neutrino mass will appear in higher order!

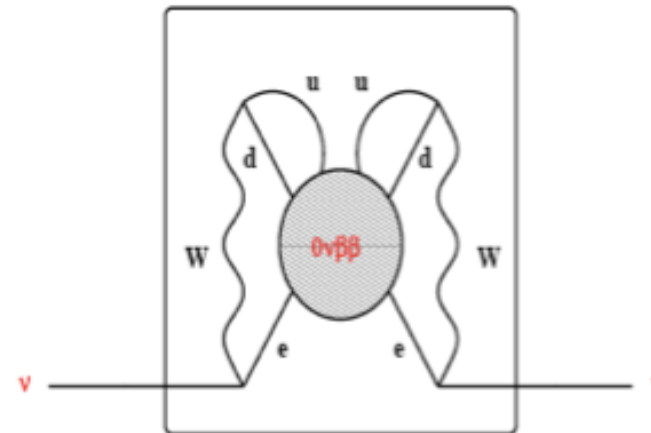

Observe $0\nu\beta\beta$ decay

\equiv

Neutrinos are Majorana particles

Flavour eigenstates needn't to be mass eigenstates

Conversion by unitary transformation

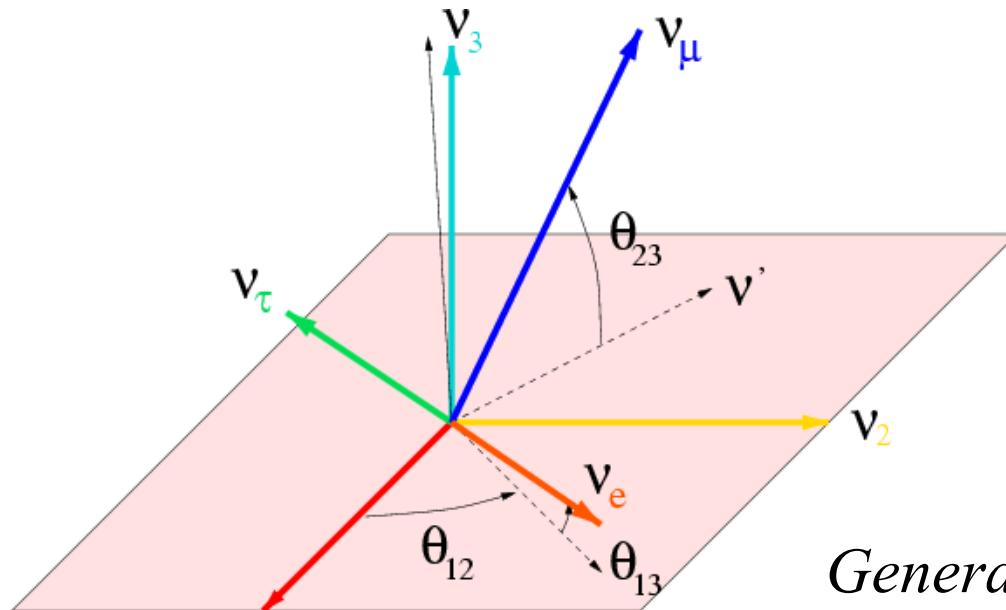

$$|v_i\rangle = \sum U_{\alpha i} |v_\alpha\rangle$$

2 Flavour Scenario

$$U = \begin{pmatrix} \cos \Theta & \sin \Theta \\ -\sin \Theta & \cos \Theta \end{pmatrix}$$

General parametrisation – 3 states

$$U = \begin{pmatrix} c_{12}c_{13} & s_{12}c_{13} & s_{13}e^{-i\delta} \\ -s_{12}c_{23} - c_{12}s_{23}s_{13}e^{i\delta} & c_{12}c_{23} - s_{12}s_{23}s_{13}e^{i\delta} & s_{23}c_{13} \\ s_{12}s_{23} - c_{12}s_{23}s_{13}e^{i\delta} & -c_{12}s_{23} - s_{12}c_{23}s_{13}e^{i\delta} & c_{23}c_{13} \end{pmatrix}$$

3 angles and 1 complex phase

Neutrinos mix as oscillation experiments have shown, hence

Leptonic mixing (PMNS) matrix (including Majorana character)

$$U = \begin{pmatrix} \cos\theta_{12} & \sin\theta_{12} & 0 \\ -\sin\theta_{12} & \cos\theta_{12} & 0 \\ 0 & 0 & 1 \end{pmatrix} \begin{pmatrix} \cos\theta_{13} & 0 & \sin\theta_{13}e^{-i\delta} \\ 0 & 1 & 0 \\ -\sin\theta_{13}e^{i\delta} & 0 & \cos\theta_{13} \end{pmatrix} \begin{pmatrix} 1 & 0 & 0 \\ 0 & \cos\theta_{23} & \sin\theta_{23} \\ 0 & -\sin\theta_{23} & \cos\theta_{23} \end{pmatrix} \begin{pmatrix} 1 & 0 & 0 \\ 0 & e^{i\alpha_1} & 0 \\ 0 & 0 & e^{i\alpha_2} \end{pmatrix}$$

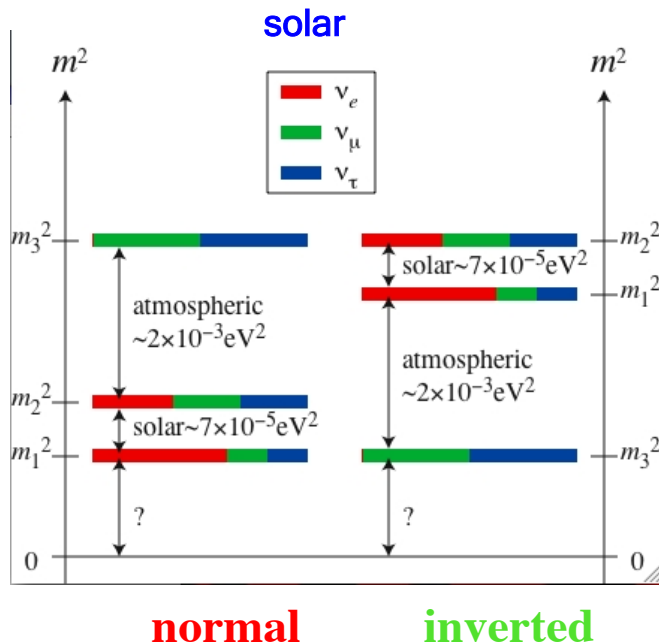

reactor

atmospheric

$$\langle m_\nu \rangle = \left| \sum_i U_{ei}^2 m_{\nu_i} \right| = \left| c_{12}^2 c_{13}^2 m_1 + s_{12}^2 c_{13}^2 e^{i2\alpha_1} m_2 + s_{13}^2 e^{i2(\alpha_2 - \delta)} m_3 \right|$$

From oscillation experiments

$$\sin^2 2\theta_{23} > 0.9 \text{ (90\%CL)}, \text{ best fit } \theta_{23} = 45^\circ$$

$$\sin^2 2\theta_{13} = 0.09 \text{ (90\%CL)}, \theta_{13} = 9^\circ$$

$$\sin^2 \theta_{12} = 0.32, \theta_{12} = 34.06^{+1.16}_{-0.84}$$

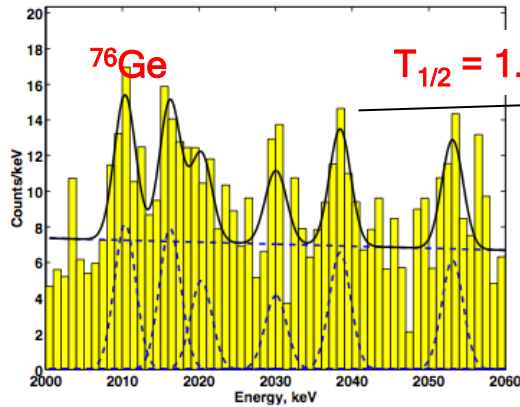

H.V. Klapdor-Kleingrothaus et al. Phys. Lett. B 586, 198 (2004)

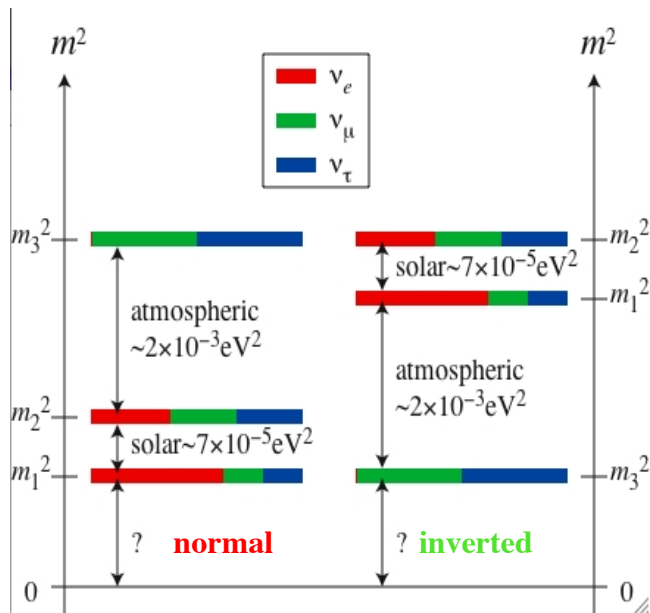
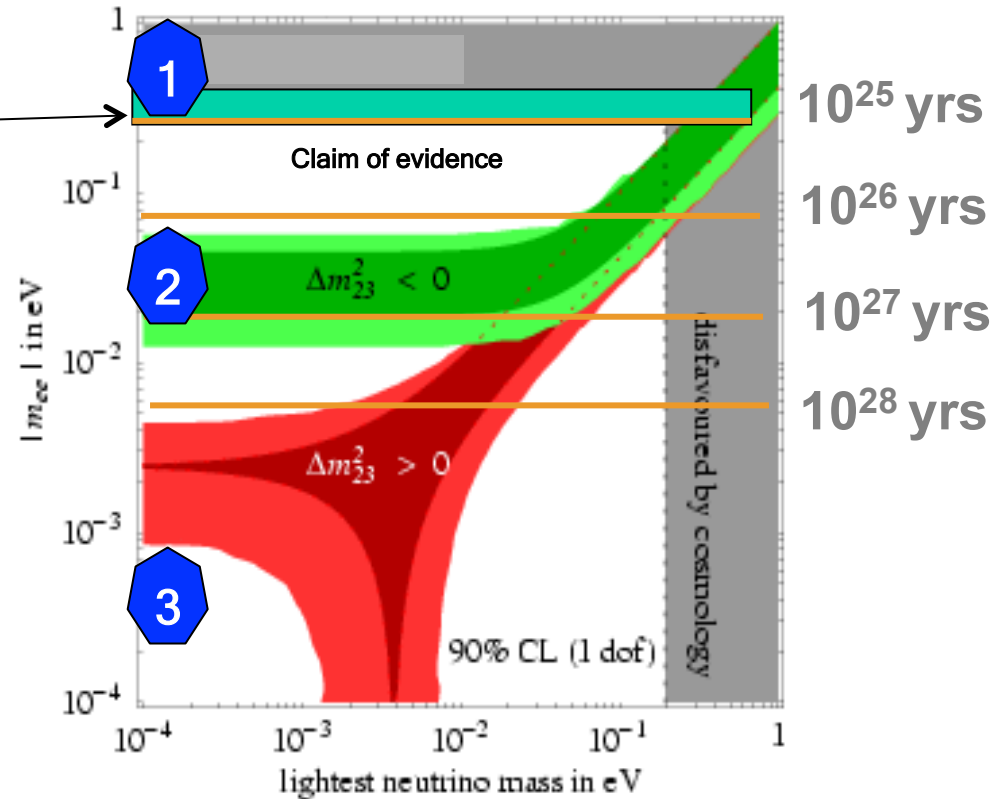

- 1.) Is the claimed evidence correct?
GERDA phase I and II, Xe-experiments
- 2.) Can we probe the inverted hierarchy?
- 3.) What about the normal hierarchy?

or



This is the 50 meV option, just add 0's to moles and kgs if you want smaller neutrino masses

$$T_{1/2} = \ln 2 \cdot a \cdot N_A \cdot M \cdot t / N_{\beta\beta} (\tau_{\gg T}) \quad (\text{Background free})$$

For half-life measurements of 10^{26-27} yrs

1 event/yr you need 10^{26-27} source atoms

This is about 1000 moles of isotope, implying about 100 kg

Now you only can loose: nat. abundance, efficiency, background, ...



$0\nu\beta\beta$: Peak at Q-value of nuclear transition

Sum energy spectrum of both electrons

Measured quantity: Half-life

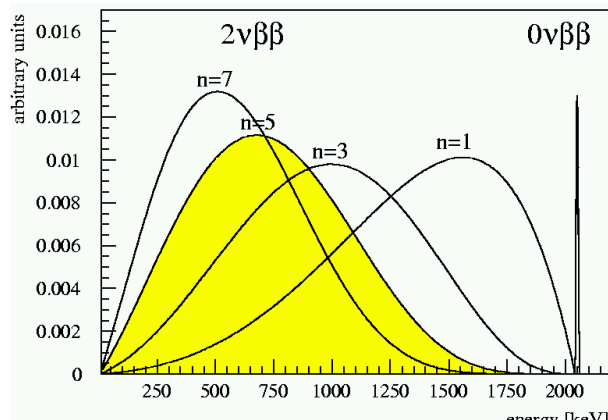

$$1 / T_{1/2} = PS * NME^2 * (\langle m_\nu \rangle / m_e)^2$$

Experimental sensitivity depends on

$$T_{1/2}^{-1} \propto a\varepsilon \sqrt{\frac{Mt}{\Delta EB}} \quad (\text{BG limited})$$

$$T_{1/2}^{-1} \propto a\varepsilon Mt \quad (\text{BG free})$$

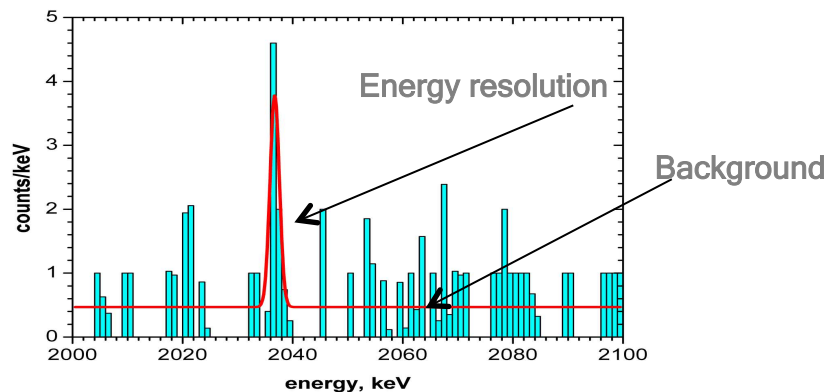

If background limited $m_\nu \propto \sqrt[4]{\frac{\Delta EB}{Mt}}$

$$1 / T_{1/2} = PS * NME^2 * (\langle m_\nu \rangle / m_e)^2$$

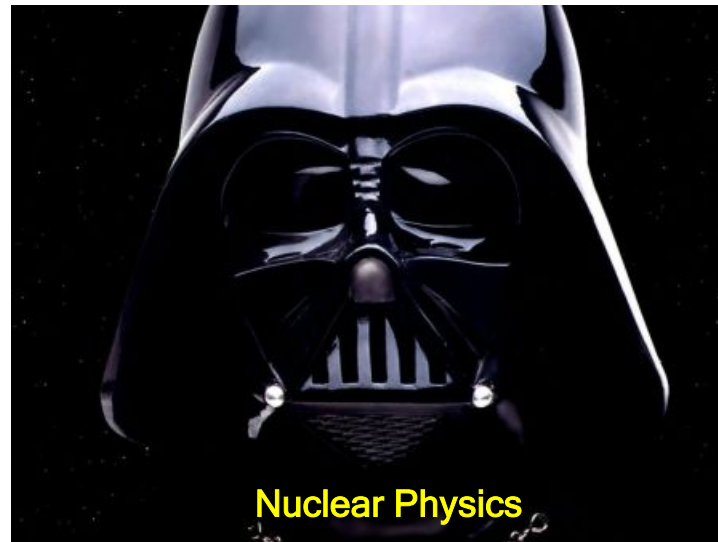

Nuclear Physics

Measurement

Exact
calculation

Complex
calculations

Quantity of
interest

J. Kotila, F. Iachello, PRC 87,034316 (2012)
S. Stoica, M. Mirea, PRC 88 ,037303 (2013)

Severe nuclear structure issue

DESY, 24.1.2018

Rescaled as people use different g_A (1-1.25) and R_0 (1.0-1.3 fm)

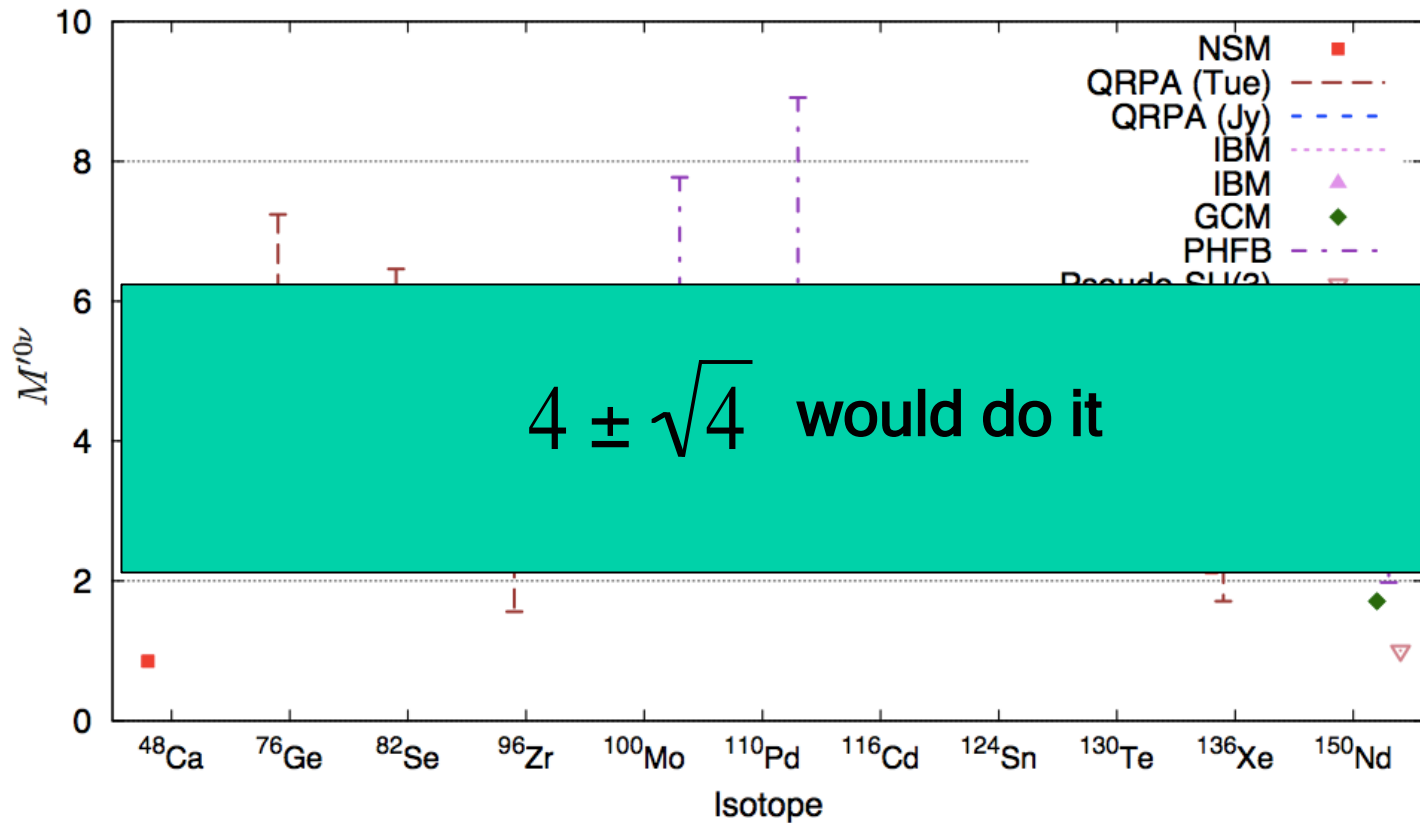

A. Dueck, W. Rodejohann, K. Zuber,
PRD 83, 113010 (2011)

Several new techniques applied in last years

DESY, 24.1.2018

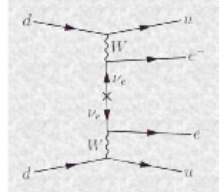

IPPP Workshop on
**Matrix Elements for Neutrinoless
Double Beta Decay**

IPPP, Durham, UK
May 23-24, 2005

Within the Standard Model lepton number is conserved, and so neutrinoless double beta decay (0NU2BD) is forbidden. However, recent neutrino oscillation experiments have shown that neutrinos are massive particles, and imply that the description of neutrinos within the Standard Model is incomplete. To move beyond the Standard Model and formulate a new theoretical framework with which to describe neutrino phenomenology, the mass mechanism must be investigated. 0NU2BD experiments illuminate the nature of the mass term in the neutrino Lagrangian; if 0NU2BD is observed, the neutrino must be a Majorana particle. This represents both theoretical and experimental challenges. In particular, the extraction of precise information on neutrinos is impossible without a detailed understanding of the nuclear matrix elements that enter in the expressions for the decay widths.



The Workshop will focus on the status of and prospects for the nuclear matrix element calculations and measurements that are a key factor in extracting information on the neutrino masses in neutrinoless double decay processes.

The Workshop will take place at the Institute for Particle Physics Phenomenology, University of Durham, Durham, UK. Participants will be accommodated nearby. Because accommodation is strictly limited, attendance is by invitation only. If you wish to attend, please email one of the organisers listed below.

The meeting will start will start at 9.00am on Monday 23rd May and end at lunchtime on Tuesday 24th May 2005. Participants are expected to arrive on Sunday 22nd May. There is no fee and participants' local costs will be paid by the IPPP. There will a conference dinner on the evening of Monday 23rd May, and buffet lunches will be provided on both days.

[Programme](#)

[Participants](#)

[Travelling to Durham](#)

Organisers:

[Kai Zuber \(Sussex\)](#), [James Stirling \(Durham\)](#), [Linda Wilkinson \(Durham\)](#)

Working packages

Precise Q-value measurements

Charge exchange reactions

Ordinary muon capture

Double electron captures

Neutrino-Nucleus scattering

Nucleon transfer reactions

Consensus Report:
K. Zuber, nucl-ex/0511009

DESY, 24.1.2018

$$(T_{1/2}^{0\nu})^{-1} = G^{0\nu} g_A^4 |M^{0\nu}|^2 \left(\frac{\langle m_{ee} \rangle}{m_e} \right)^2$$

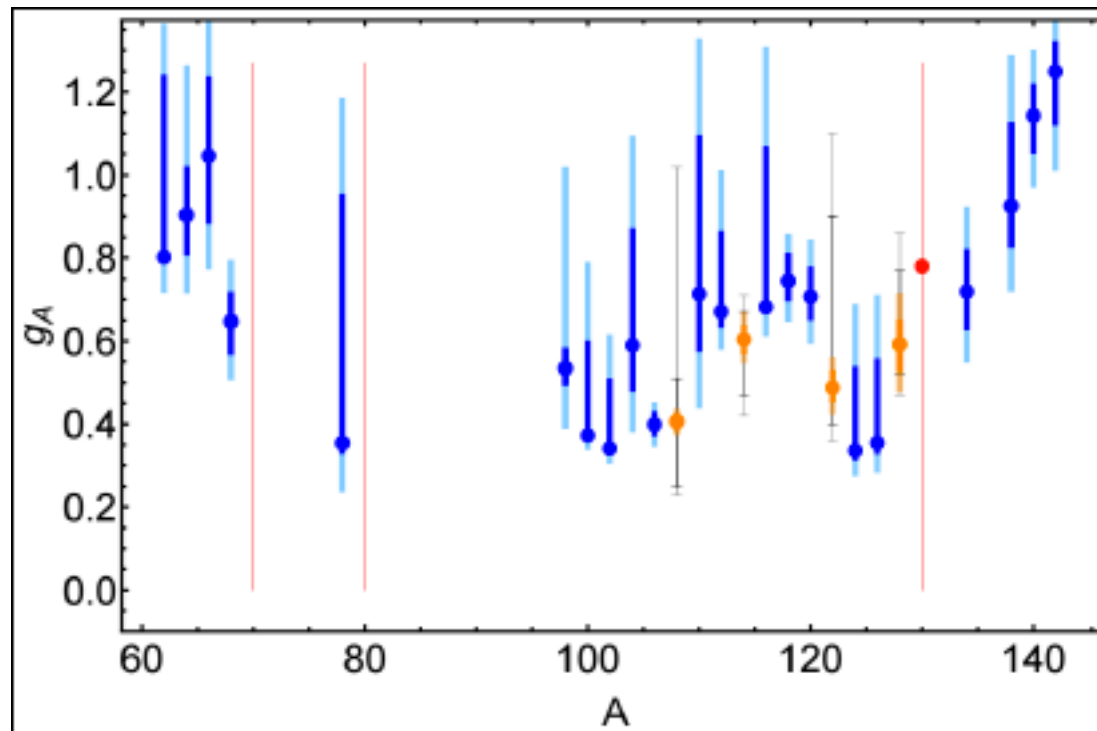

F. Deppisch, J. Suhonen, PRC 91,055501 (2016)
 J. Suhonen, arXiv:1712.01565

$0\nu\beta\beta$ decay rate scales with $Q^5 \rightarrow$ only those with $Q > 2000$ keV

11 isotopes of interest

Isotope	Nat. abund. (%)	Q-values 2016
Ca-48	0.187	4262.96 ± 0.84
Ge-76	7.44	2039.006 ± 0.050
Se-82	8.73	2997.9 ± 0.3
Zr-96	2.80	3356.097 ± 0.086
Mo-100	9.63	3034.40 ± 0.17
Pd-110	11.72	2017.85 ± 0.64
Cd-116	7.49	2813.50 ± 0.13
Sn-124	5.79	2292.64 ± 0.39
Te-130	33.80	2527.518 ± 0.013
Xe-136	8.9	2457.83 ± 0.37
Nd-150	5.64	3371.38 ± 0.20

Candles

GERDA, Majorana, LEGEND

SuperNEMO, LUCIFER

MOON, AMore

COBRA

Tin.Tin

CUORE, SNO+

nEXO, KamLAND-Zen, NEXT, XMASS

MCT, SuperNEMO



There is no super-isotope!

Idea : Running bare Ge crystals in LAr

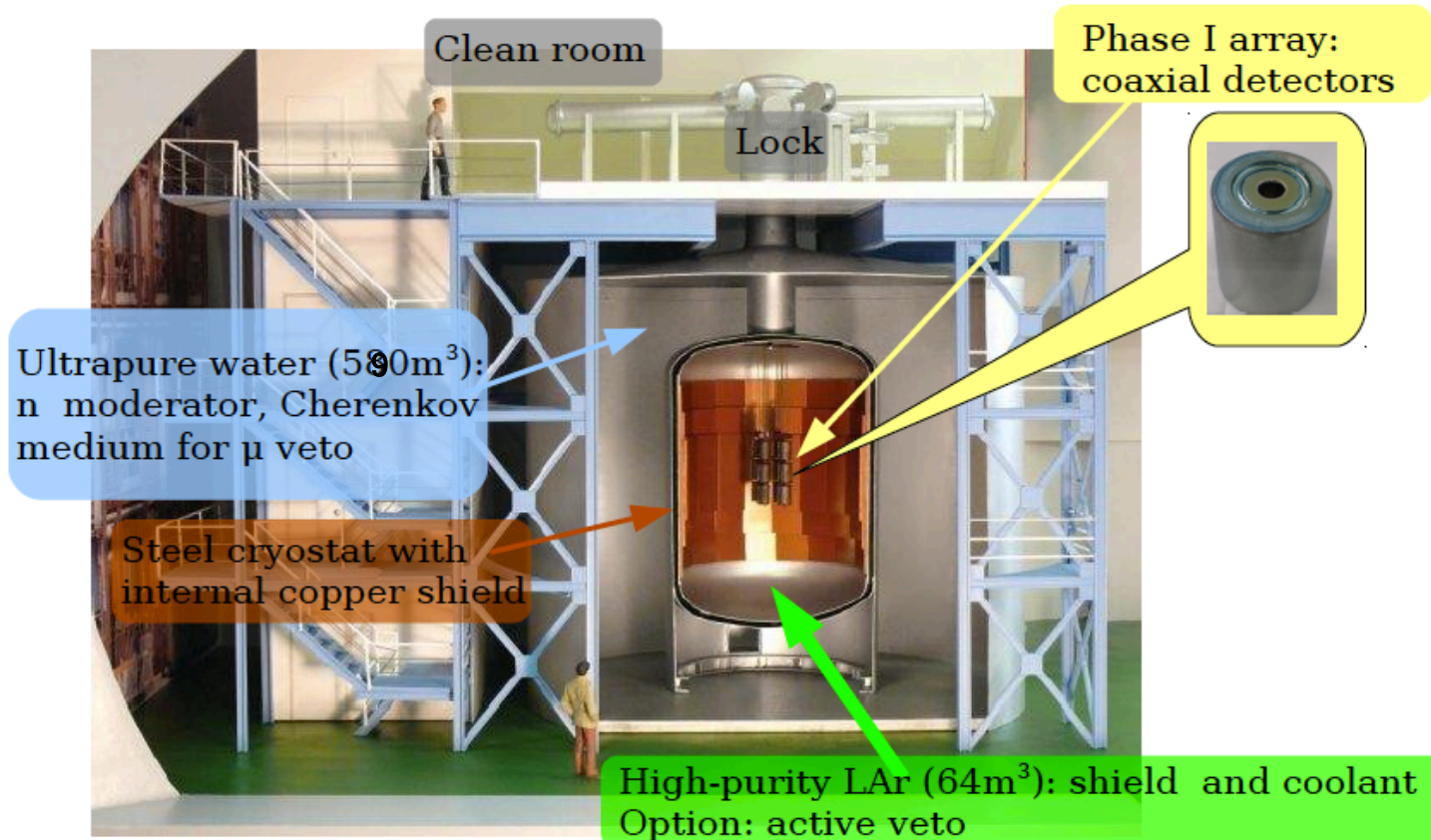

The Gerda experiment for the search of $0\nu\beta\beta$ decay in ^{76}Ge
Eur. Phys. J. C (2013) 73:2330



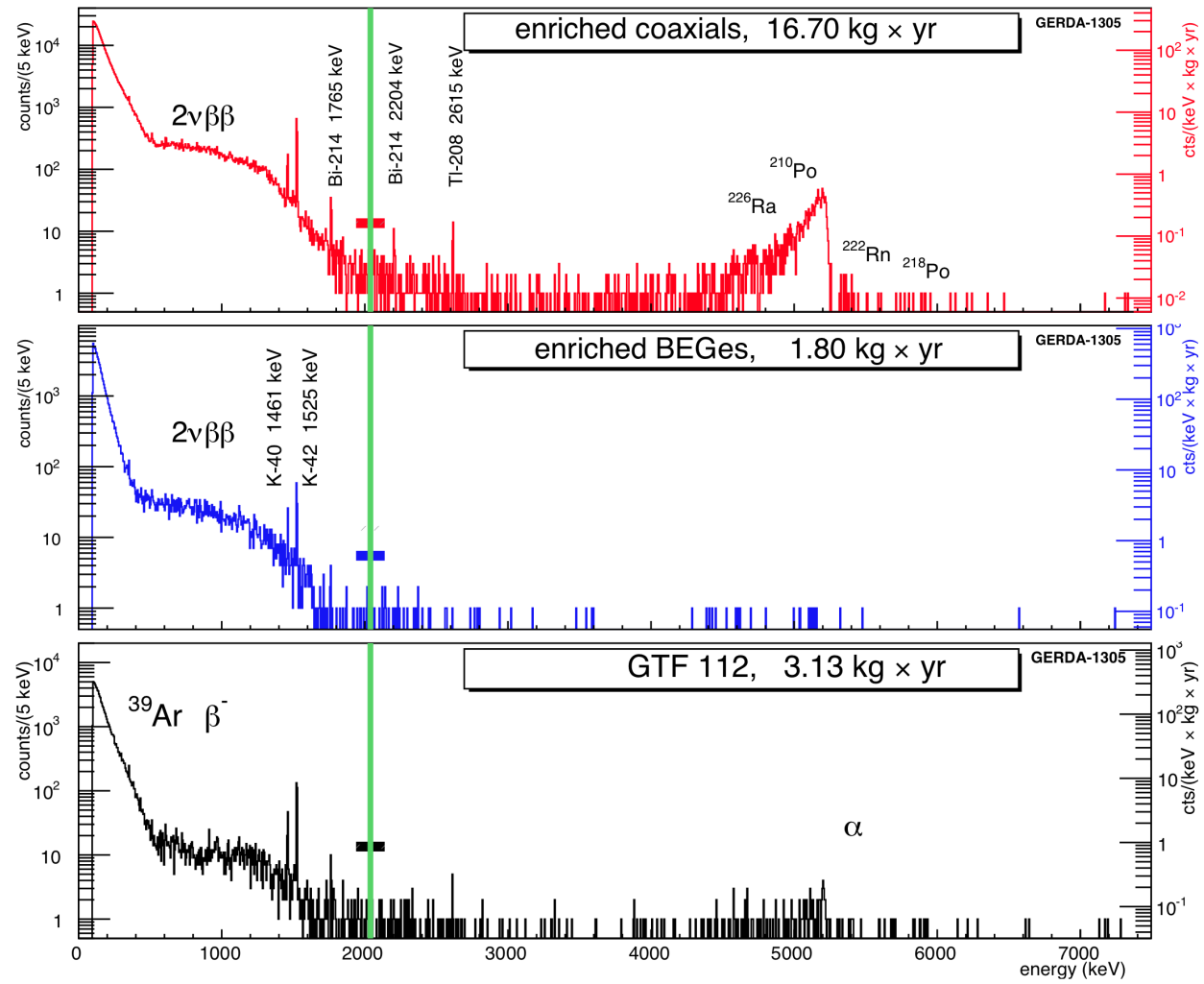

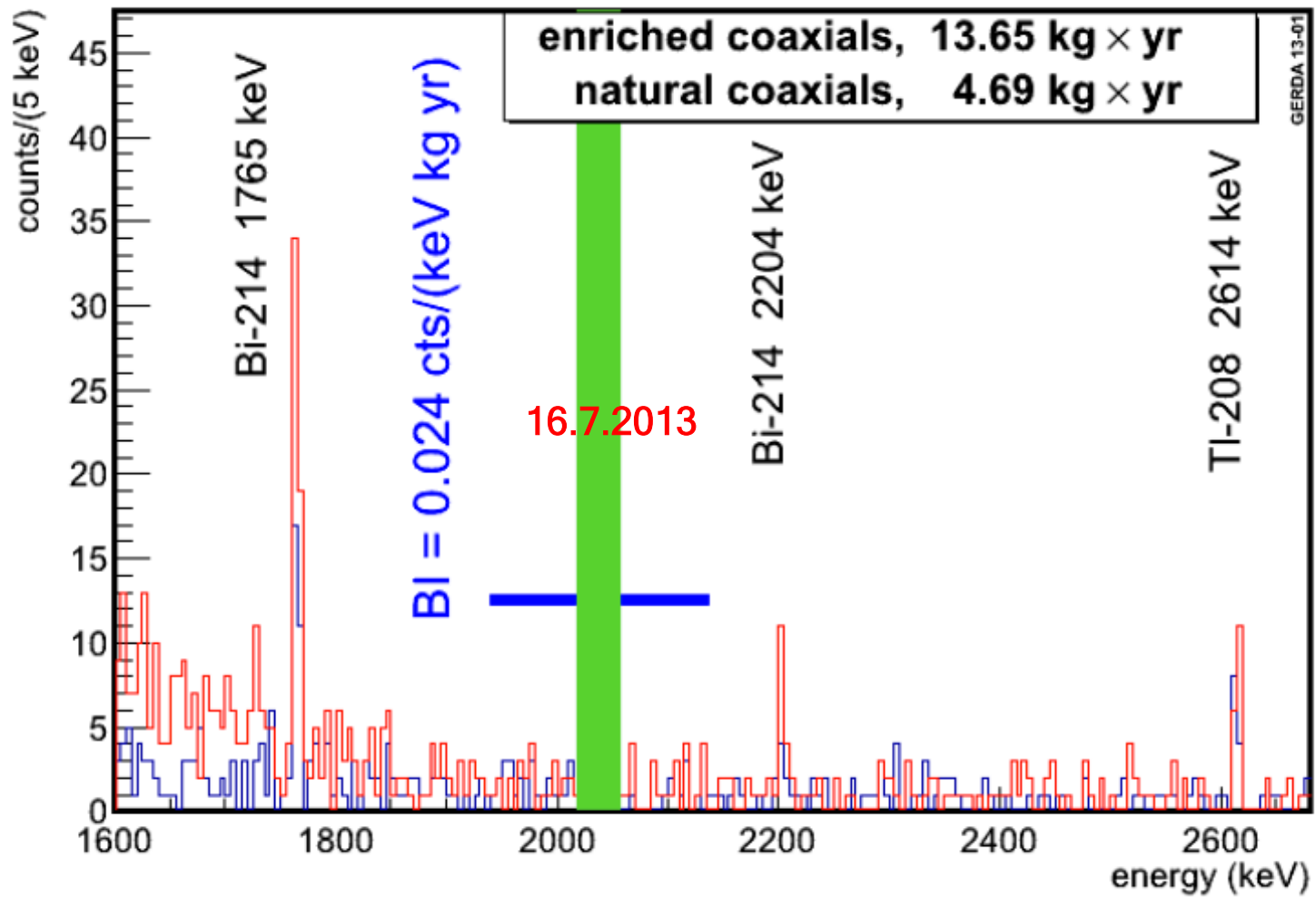

Adding another 20 kg (total of 35.6 kg) of enriched Ge-76 in form of BEGe detectors

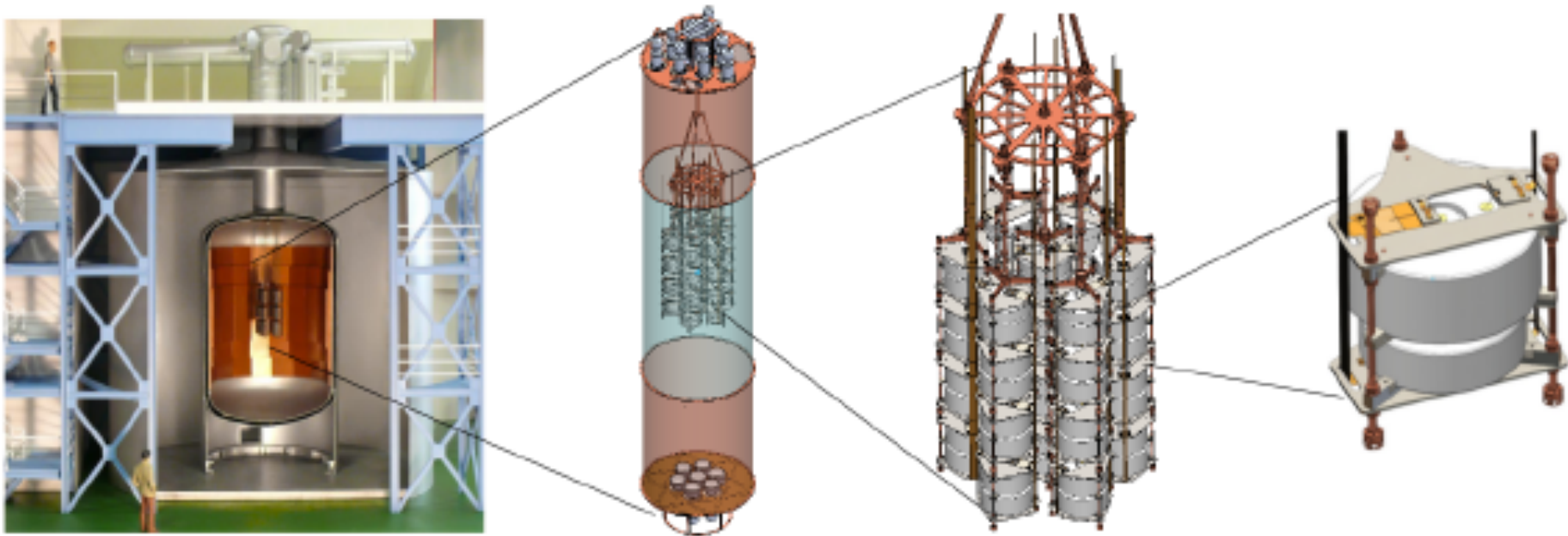

Achieved background level of 10^{-3} counts/keV/kg/yr

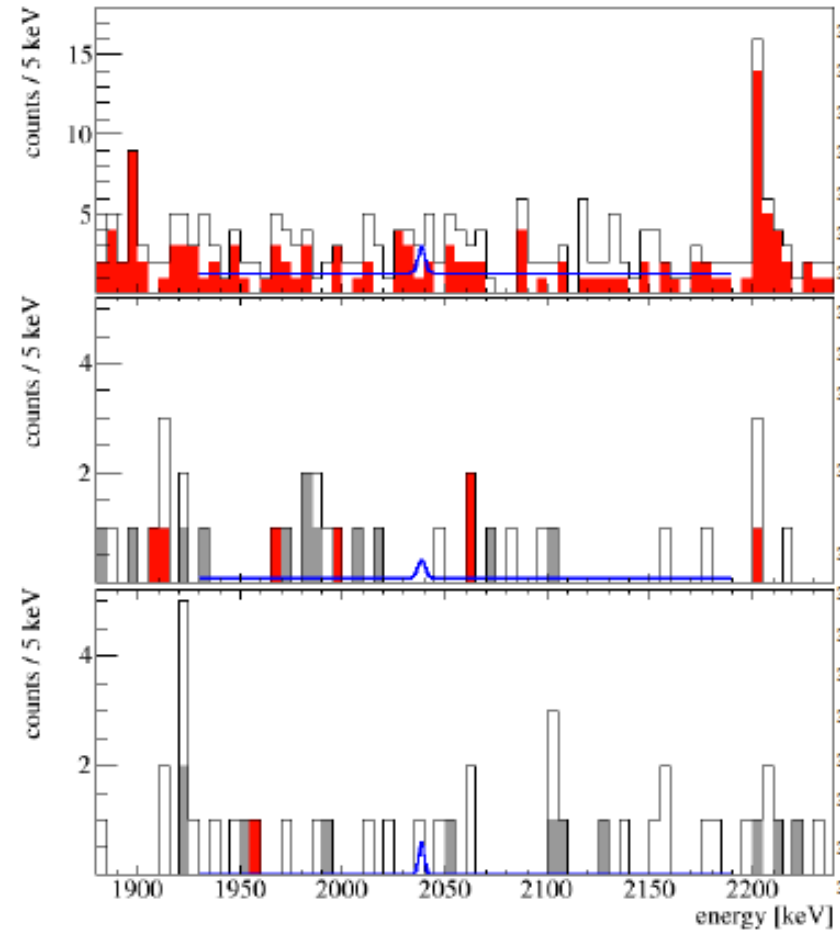
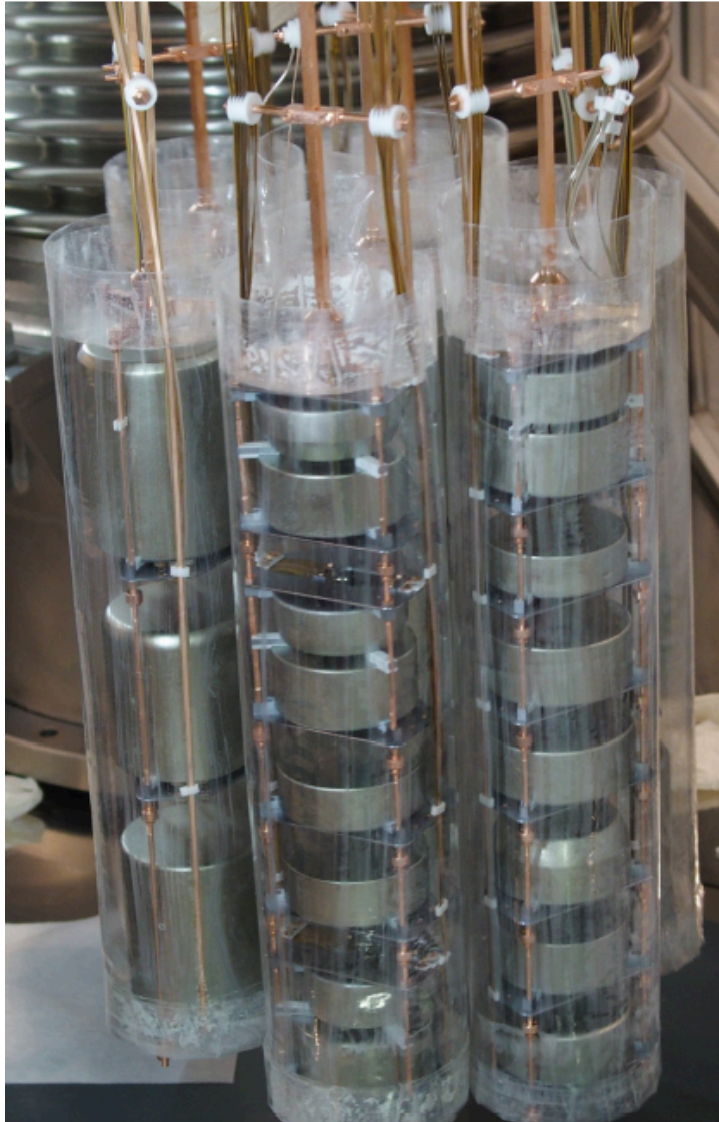

$$T_{1/2}^{0\nu} > 5.2 \cdot 10^{25} \text{ yr} \quad (90\% \text{ CL})$$

M. Agostini et al., Nature 544, 47 (2017)

DESY, 24.1.2018

Rules out claimed evidence

- Aim of GERDA phase II is 100 kg*yr exposure (background free)

- Expected sensitivity is 1.4×10^{26} yrs , end of experiment in 2019

- Next step:

LEGEND experiment (merging of GERDA and MAJORANA + new members)

Phase I: LEGEND-200, 200 kg of enriched Ge, experiment at LNGS

Phase II: LEGEND -1000, 1000 kg of enriched Ge
(aim is to beat half-life of 10^{28} years)

Idea: use room-temperature CdZnTe (CZT) semiconductor detectors

K. Zuber, Phys. Lett. B 519,1 (2001)

- Search for DBD of **Cd-116** (Q-value = 2814 keV)
- Allows for searches of Te-130, Te-128, Zn-70, Cd-114 (two electrons)
- Allows for searches of Zn-64, **Cd-106**, Cd-108, Te-120 (positron/EC)
- Precision measurement of 4-fold forbidden Cd-113 beta decay

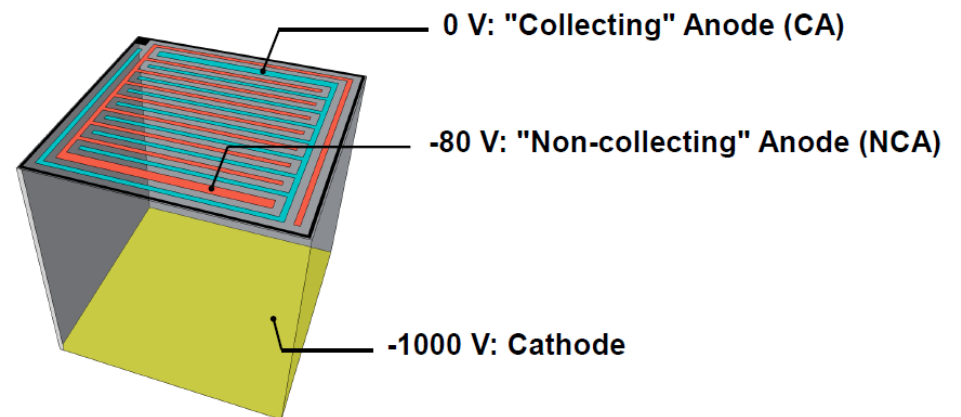
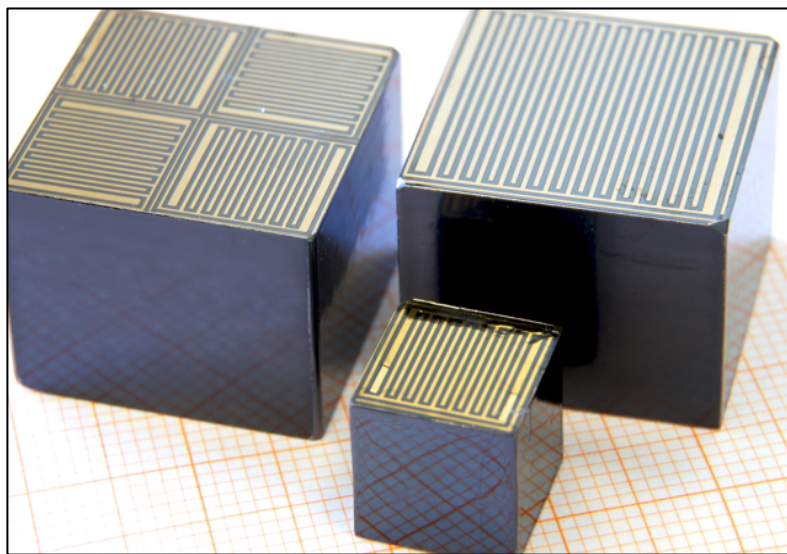

The case of ^{113}Cd



4-fold forbidden non-unique beta decay ($1/2^+ \rightarrow 9/2^+$)

COBRA double beta decay experiment (64 CdZnTe detectors)

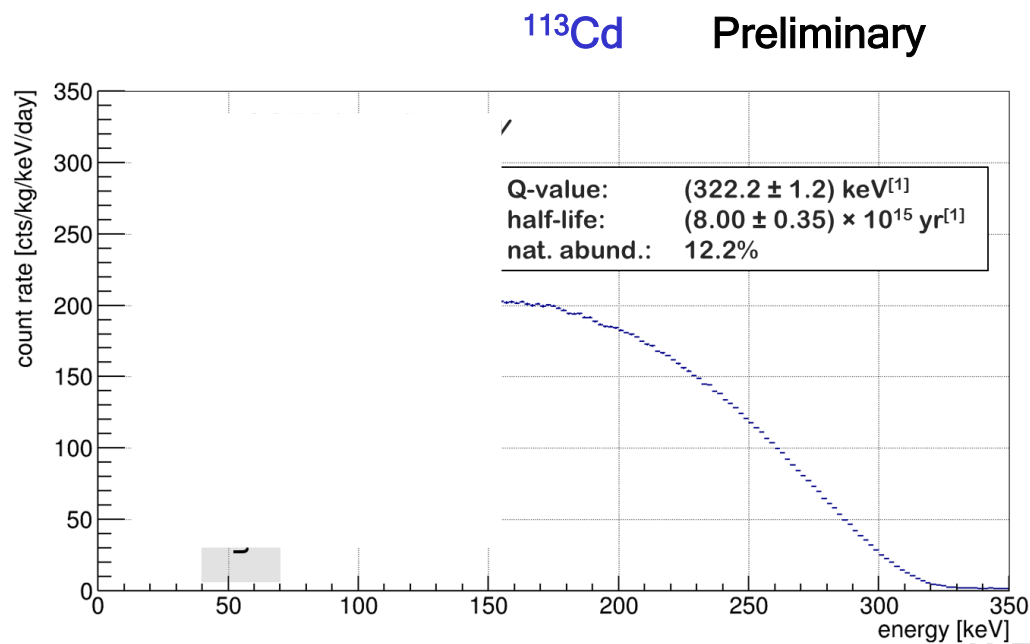

Q-value:

$$322 \pm 0.3(\text{stat.}) \pm 0.9(\text{sys.}) \text{ keV}$$

J. V. Dawson et al., Nucl. Phys. A 818,264 (2009)

AME 2016 value: 322.6 0.8 keV

Penning trap value: 323.89 (27) keV

N. D. Gamage et al., Phys. Rev. C 94,025505 (2016)

Shape depends on g_A

M. T. Mustonen, M. Aunola, J. Suhonen, PRC 73,054301 (2006)

M. T. Mustonen, J. Suhonen, PLB 657,38 (2007)

Status: COBRA modified for low threshold, data taking has started

Charged lepton flavour violation (CLFV)



DBD limits have improved by about a factor 10 in 15 years (optimistic)



If you want to have fun: Factor 10000 in 8 years



Mu2e

Focus: Coherent muon - electron conversion on nuclei (coherent = via ground state)

CLFV

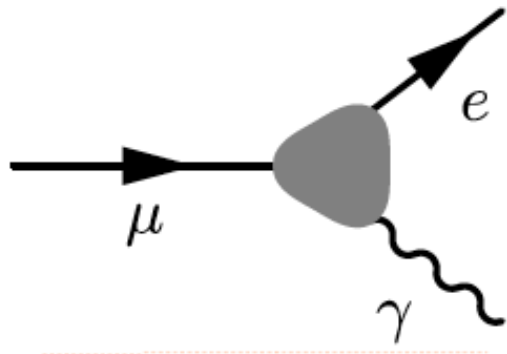

$$\mu^+ \rightarrow e^+ + \gamma$$

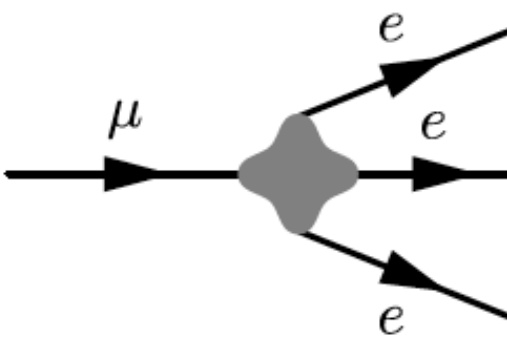
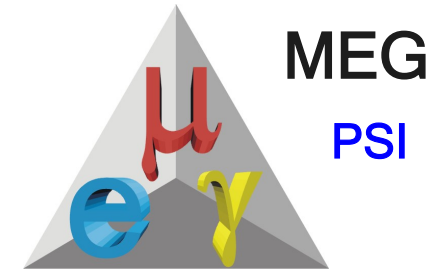

$$\mu^+ \rightarrow e^+ + e^+ + e^-$$

Mu3e

PSI

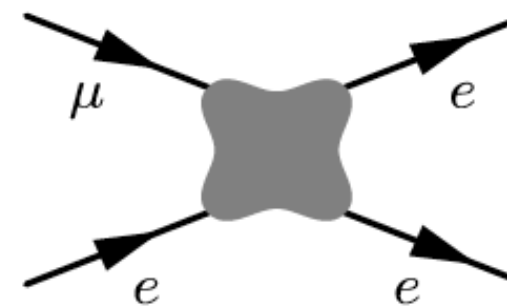

$$\mu^- + N \rightarrow e^- + N$$



J-PARC

+

Mu2e

Fermilab

Theory – “DNA”



	AC	RVV2	AKM	δ LL	FBMSSM	LHT	RS
$D^0 - \bar{D}^0$	★★★★	★	★	★	★	★★★★	?
ϵ_K	★	★★★★	★★★★	★	★	★★	★★★★
$S_{\psi\phi}$	★★★★	★★★★	★★★★	★	★	★★★★	★★★★
$S_{\phi K_S}$	★★★★	★★	★	★★★★	★★★★	★	?
$A_{CP}(B \rightarrow X_s \gamma)$	★	★	★	★★★★	★★★★	★	?
$A_{7,8}(B \rightarrow K^* \mu^+ \mu^-)$	★	★	★	★★★★	★★★★	★★	?
$A_9(B \rightarrow K^* \mu^+ \mu^-)$	★	★	★	★	★	★	?
$B \rightarrow K^{(*)} \nu \bar{\nu}$	★	★	★	★	★	★	★
$B_s \rightarrow \mu^+ \mu^-$	★★★★	★★★★	★★★★	★★★★	★★★★	★	★
$K^+ \rightarrow \pi^+ \nu \bar{\nu}$	★	★	★	★	★	★★★★	★★★★
$K_L \rightarrow \pi^0 \nu \bar{\nu}$	★	★	★	★	★	★★★★	★★★★
$\mu \rightarrow e \gamma$	★★★★	★★★★	★★★★	★★★★	★★★★	★★★★	★★★★
$\tau \rightarrow \mu \gamma$	★★★★	★★★★	★	★★★★	★★★★	★★★★	★★★★
$\mu + N \rightarrow e + N$	★★★★	★★★★	★★★★	★★★★	★★★★	★★★★	★★★★
d_n	★★★★	★★★★	★★★★	★★	★★★★	★	★★★★
d_e	★★★★	★★★★	★★	★	★★★★	★	★★★★
$(g-2)_\mu$	★★★★	★★★★	★★	★★★★	★★★★	★	?

W. Altmannshofer et al.,
Nucl. Phys. B 830, 17 (2010)

← COMET

Table 8: “DNA” of flavour physics effects for the most interesting observables in a selection of SUSY and non-SUSY models ★★★★★ signals large effects, ★★ visible but small effects and ★ implies that the given model does not predict sizable effects in that observable.

Historical development

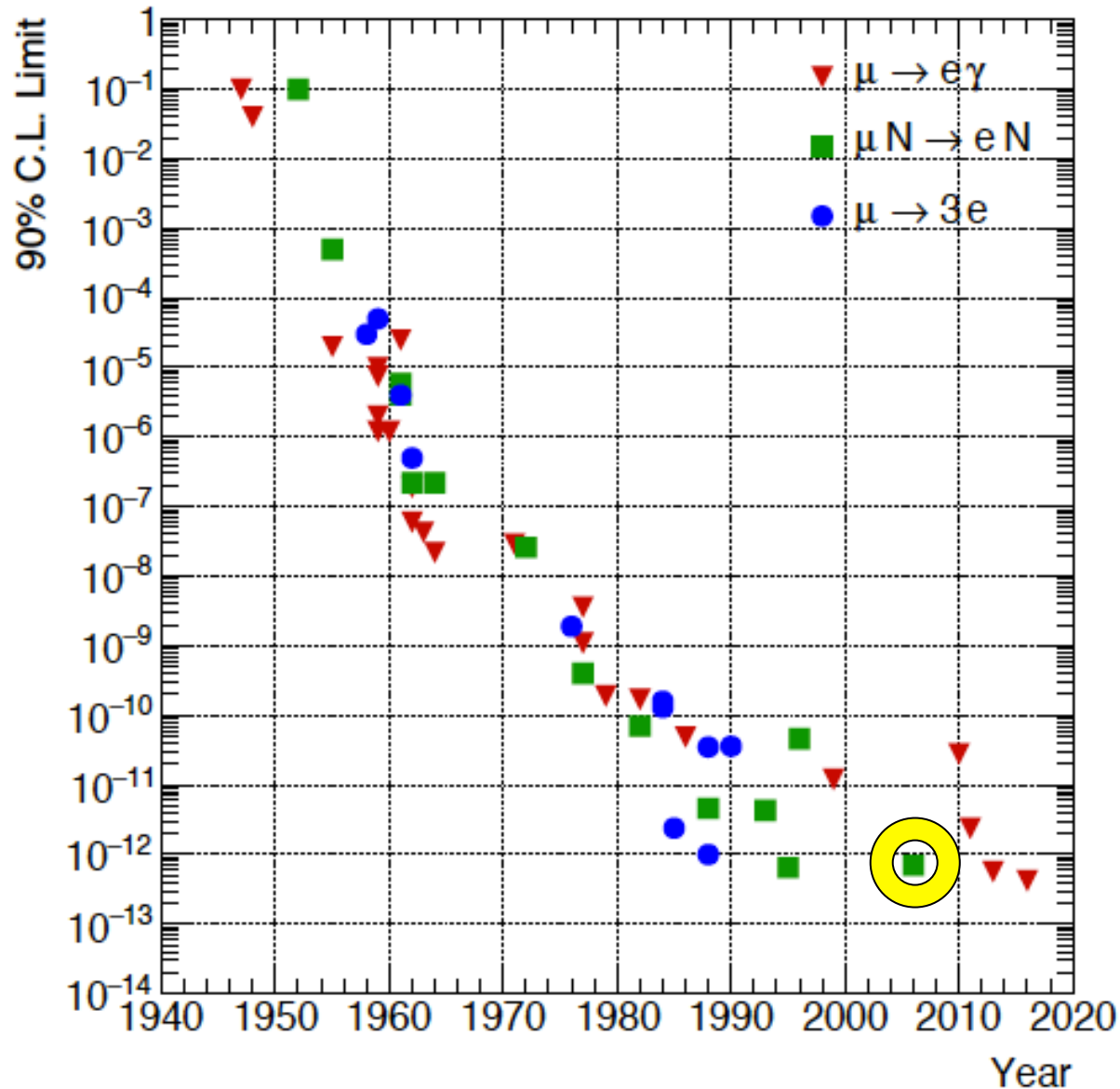

A. Baldini et al,
arXiv:1801:04688

Long time no
muon - electron
conversion
experiment

S.E.S: 6×10^{-13}

One of the major improvements: High intensity proton and therefore muon beams

Phase I

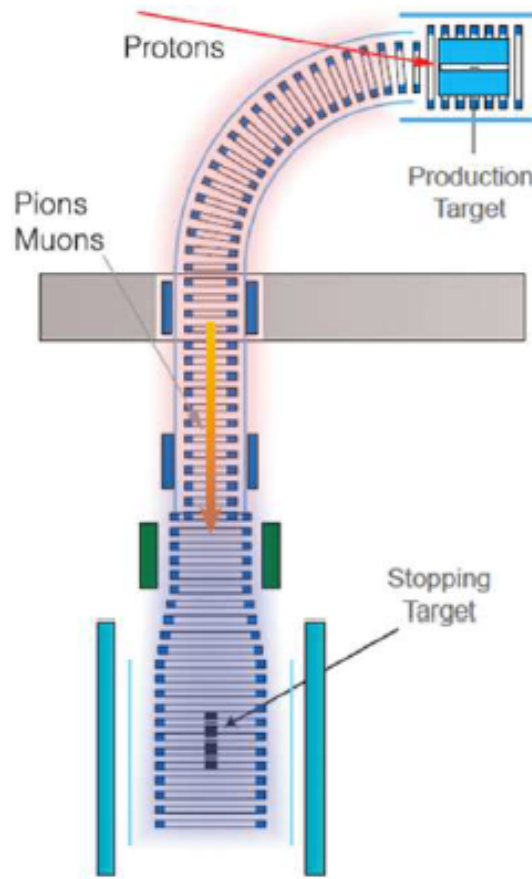

Phase II

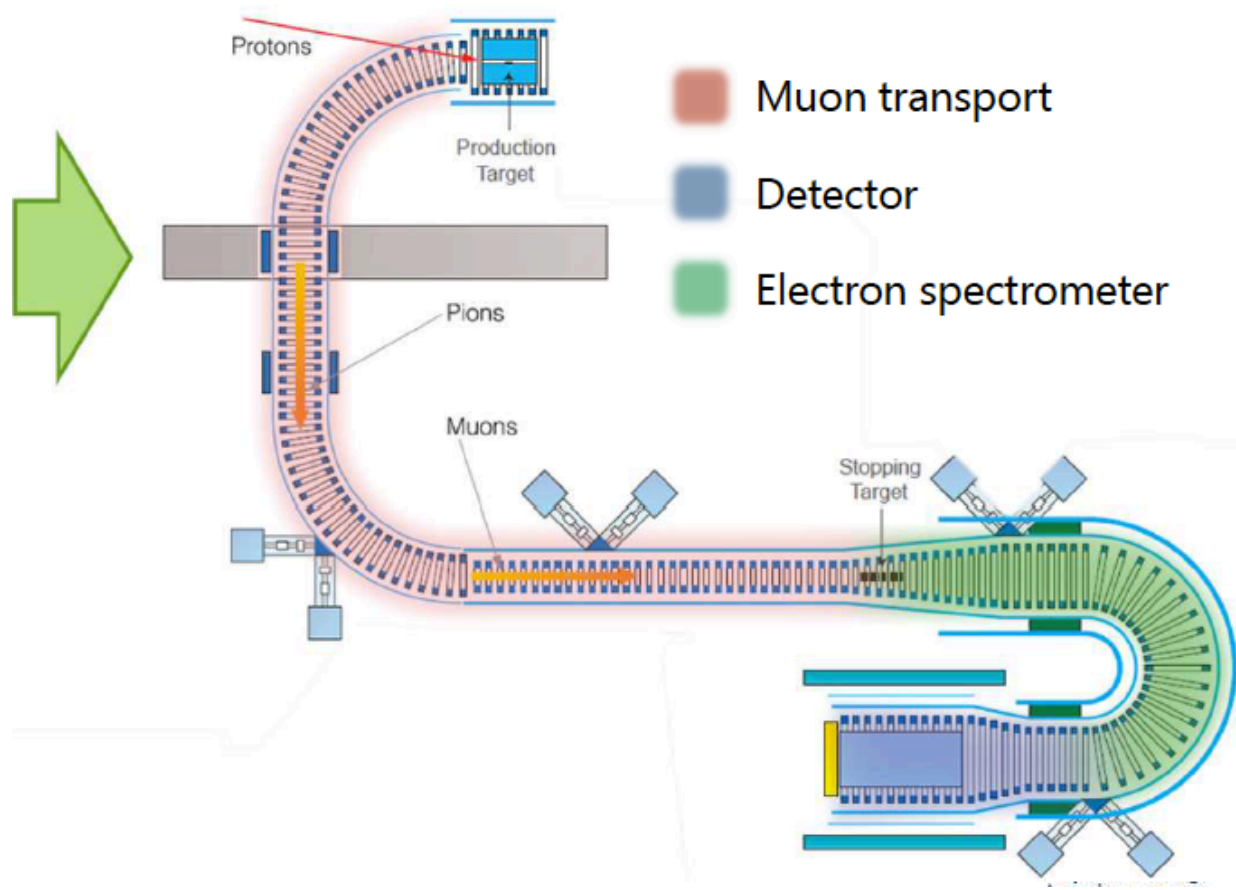

Components (some)

Stopping target

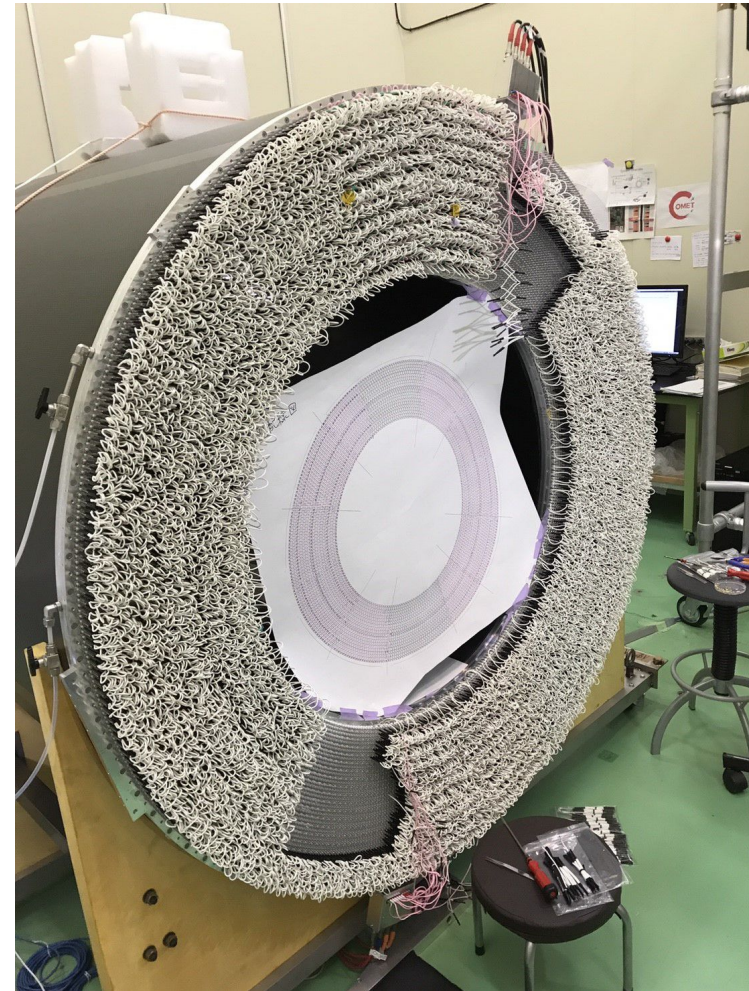
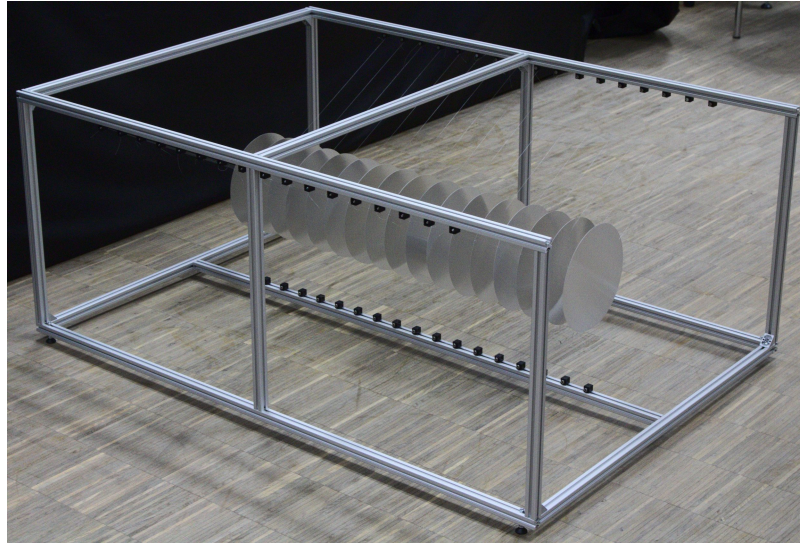

CyDet: - Stereo drift chamber
- Hodescope for timing, trigger

← Straw tubes and ECAL

Planned start in 2019/20 (commissioning and data taking)

Phase 1: **S.E.S of 3×10^{-15}** (a factor 100 improvement)

Phase 2: **S.E.S of 3×10^{-17}** (a factor 100 improvement)

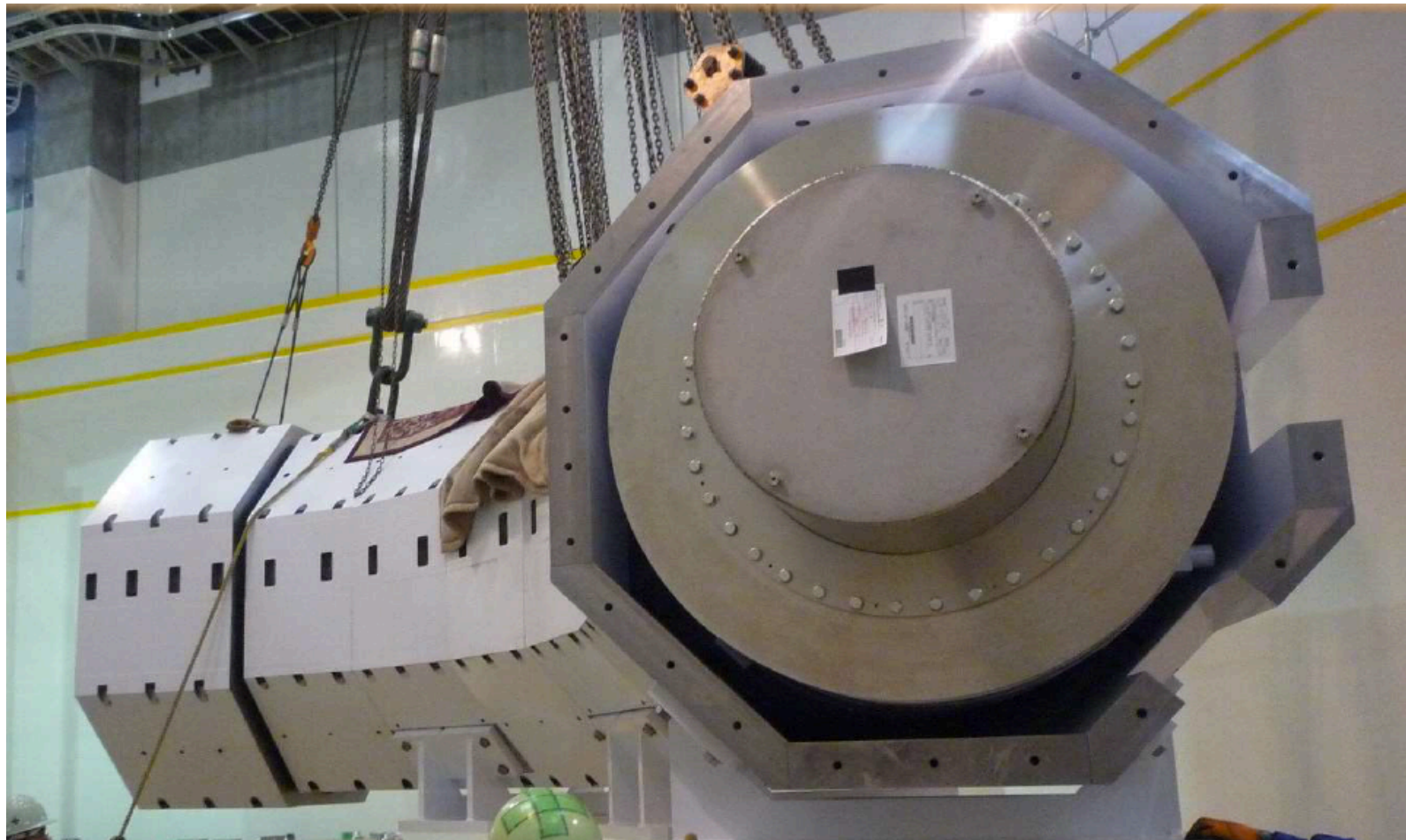

Total lepton number violation



Just a small selection

- Neutrino-less double beta decay

$$T_{1/2} \approx 10^{25-26} \text{ yrs}$$

$$\propto U_{ei}^2$$

- $\mu^- - e^+$ conversion on nuclei

T. Geib, A. Merle, K. Zuber, PLB 764,157 (2017)

B. Yeo, Y.Kuno, M. Lee, K. Zuber, PRD 96,075027 (2017)

$$\propto U_{ei} U_{\mu i}$$

- Neutrino-less double muon decay of the kaon

$$K^+ \rightarrow \pi^- \mu^+ \mu^+ \quad (< 8.6 \times 10^{-11})$$

$$\propto U_{\mu i}^2$$

K. Zuber, Phys. Lett. B 479,33 (2000)

J. Batley et al., NA48/2 coll., Phys. Lett. B 769,67 (2017)

In general: BSM physics

COMET



★ Muon–positron conversion? Similar to double beta decay

Which would be the best target for a $\mu^- - e^+$ experiment?

Major background: Radiative muon capture



$0\nu\beta\beta$

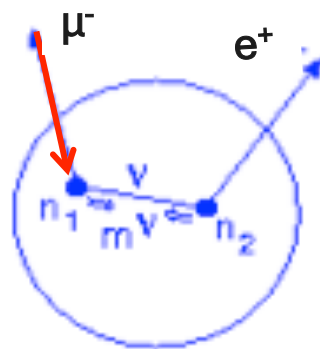

$\mu^- - e^+$

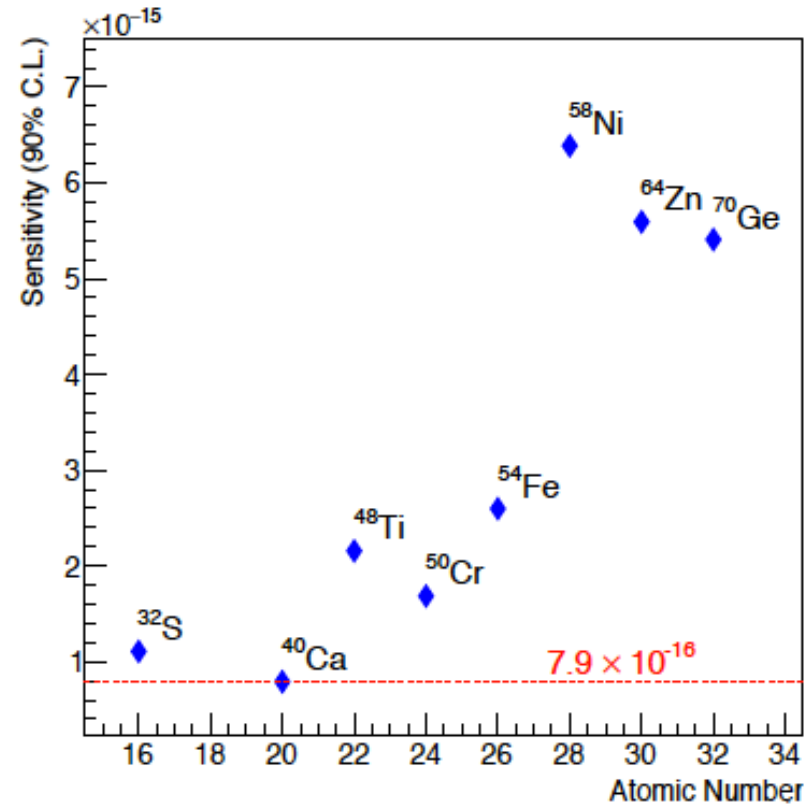

B. Yeo, Y.Kuno, M. Lee, K. Zuber, PRD 96,075027 (2017)

- **Double beta decay is of central importance for neutrino physics. Gold plated channel to probe fundamental character of neutrinos**
- **Interesting times as both LHC and double beta probe TeV scale**
- **Results from Xe-experiments and GERDA reach about 10^{26} years**
- **Further experiments are in the building up phase, several interesting experimental ideas are investigated**
- **To support matrix element calculations as much experimental input as possible on nuclear structure is desired! We are only talking about 11 isotope pairs!!!**
- **Big progress in the future is expected in charged lepton violation experiments , especially muon-electron conversion with a factor 10000**



or

