

What is a Masterclass?

EPS-HEP 2021

U. Bilow, Technische Universität Dresden, uta.bilow@tu-dresden.de

K. Cecire, University of Notre Dame, kcecire@nd.edu

www.physicsmasterclasses.org



Our standard answer *as presented two years ago to EPS-HEP...*

What is a Masterclass?

“Particle physicist for a day”

- Intro
- Tour
- Analyze authentic HEP data
- Videoconference



International Masterclasses 2019 and beyond

- > 50 Countries
- > 10^4 Students
- 4 LHC experiments
- 1 new Neutrino experiment
- More on the way



What is a Masterclass?

Interesting physics...

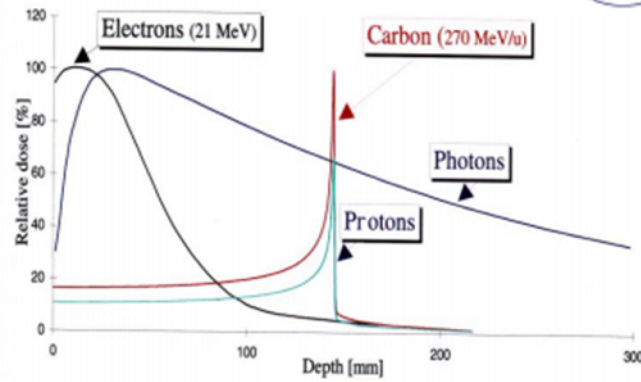
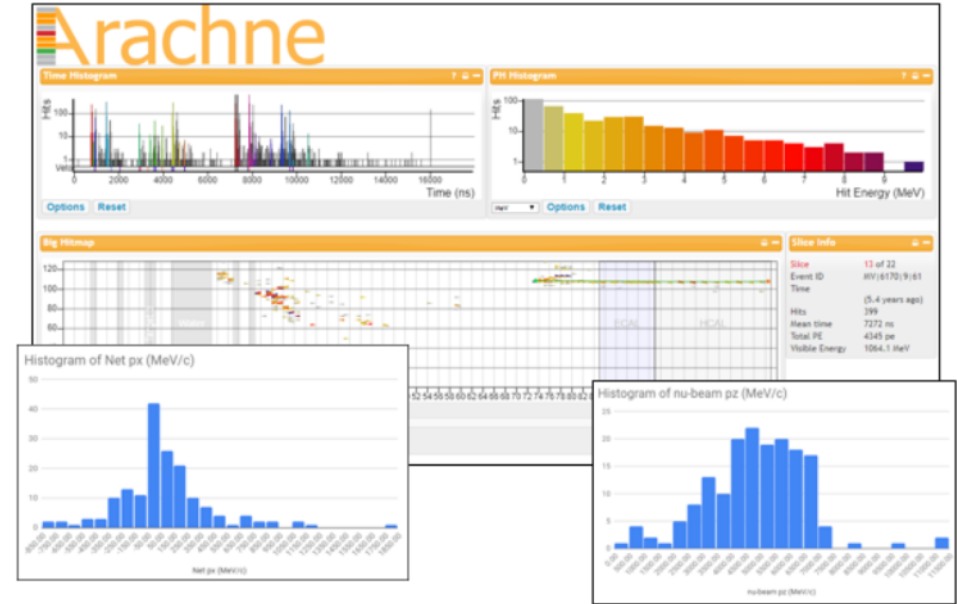
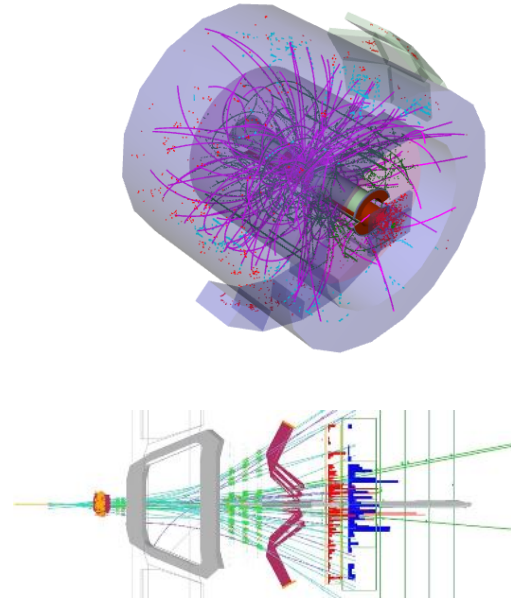
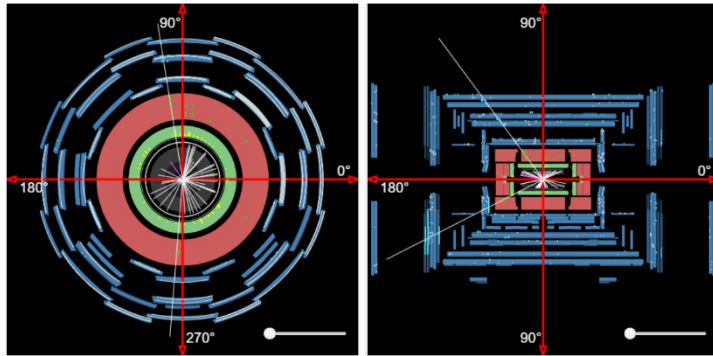

Depth in the body
(mm)

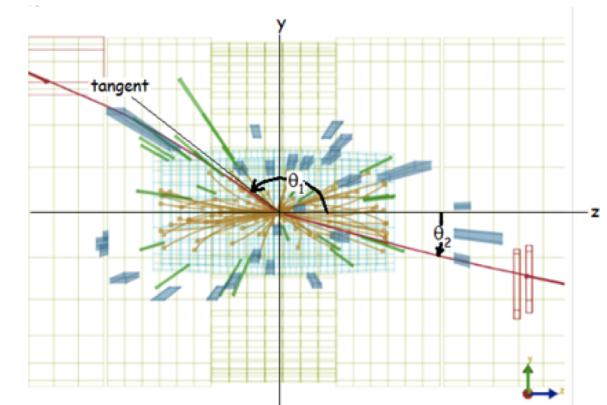
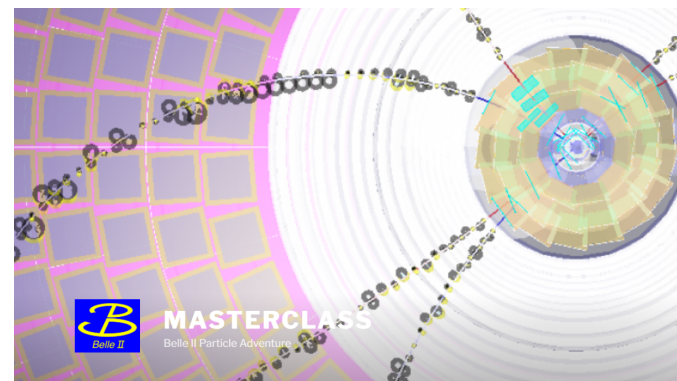

What is a Masterclass?

Physicists (especially from IPPOG)...

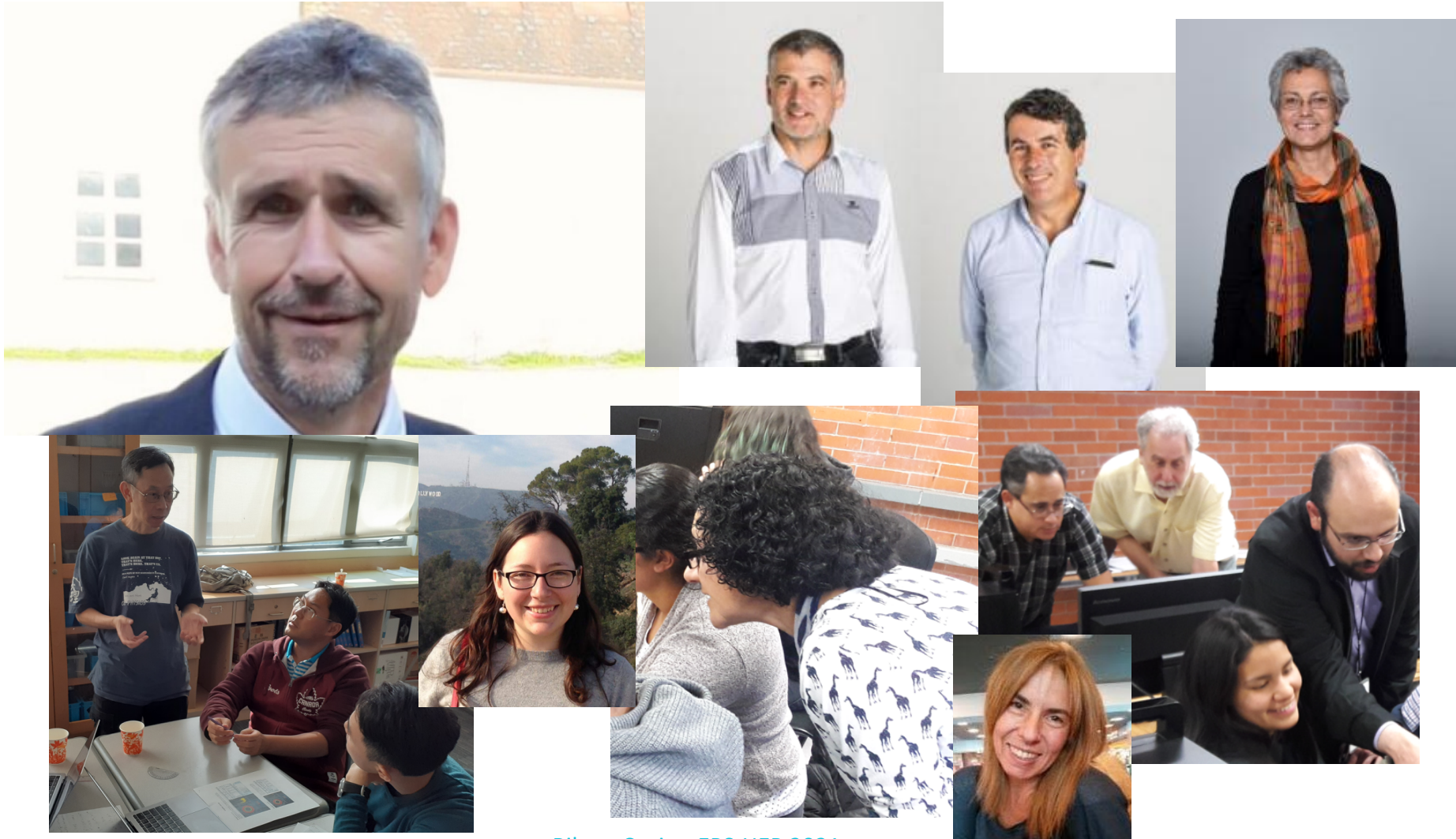

What is a Masterclass? *Students and teachers...*



What is a Masterclass? *Great collaboration.*

