

Update on LUXE GEANT4 Simulation

Oleksandr Borysov

LUXE DESY technical Meeting
January 21, 2021

BPPP spectra

BPPP Spectra

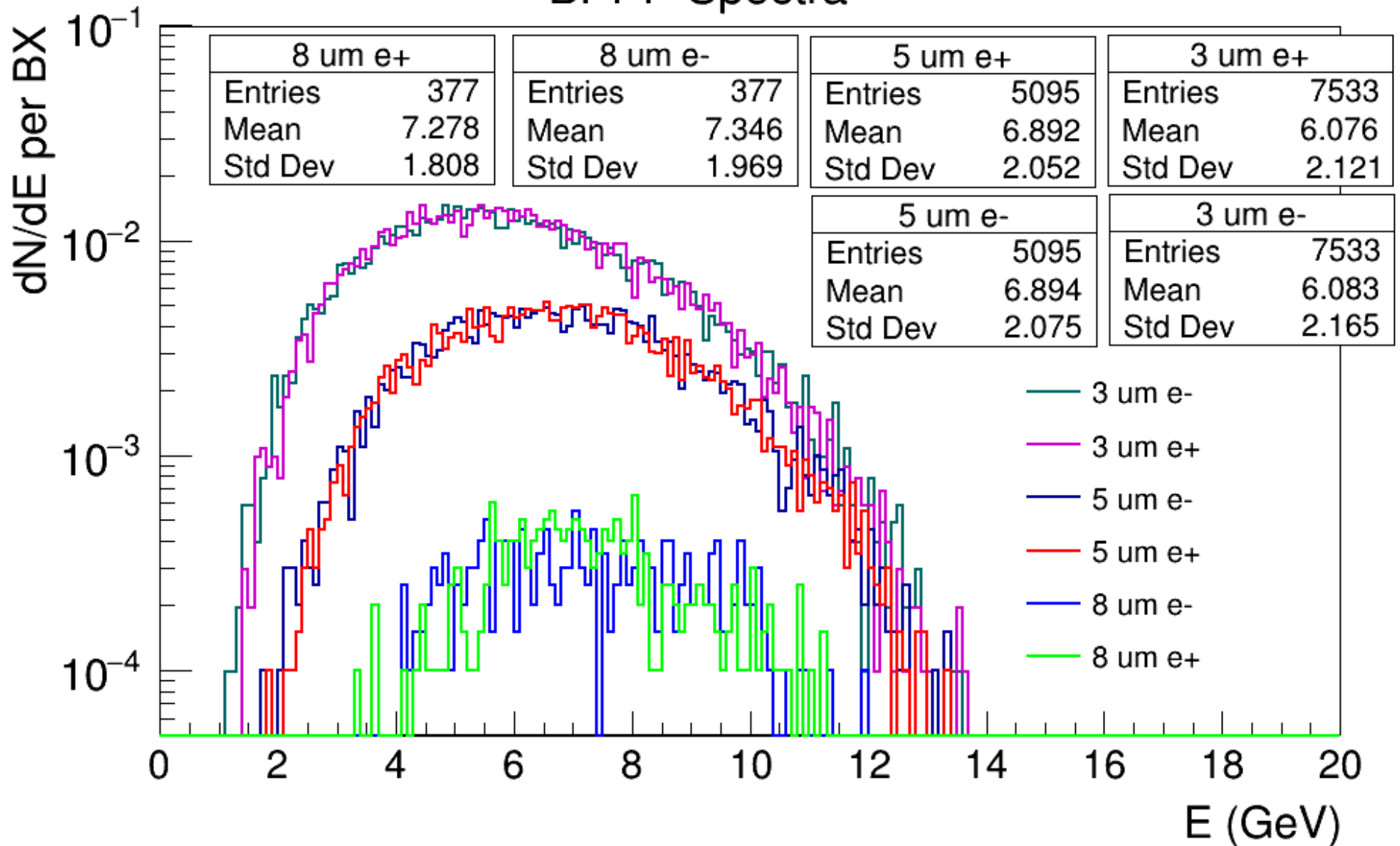

BPPP ECal signal, $w_0=3\mu\text{m}$

Geant4 simulation:

- No weight scaling;
- Modified beam pipe IPC-VC.

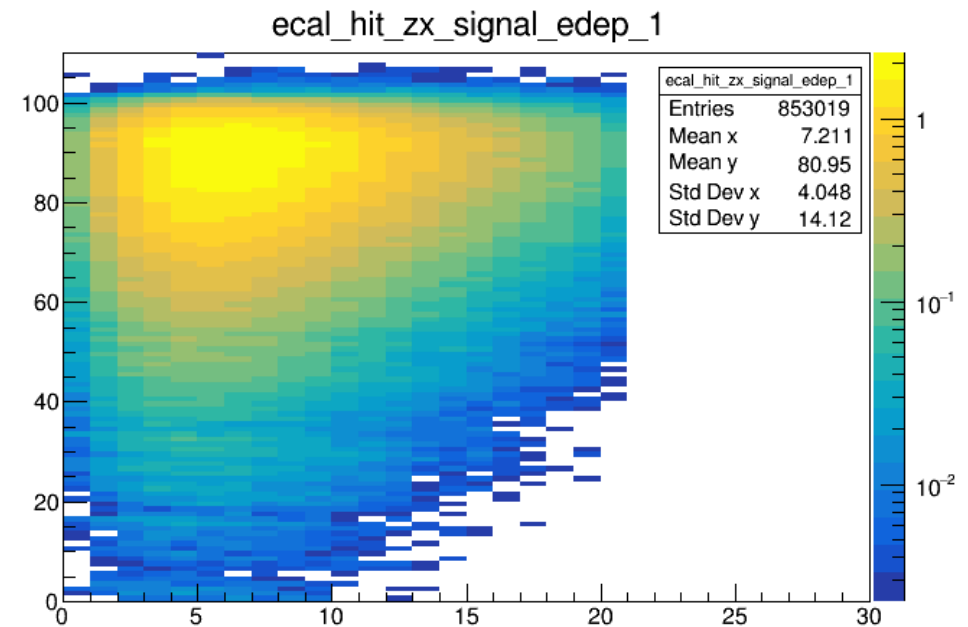
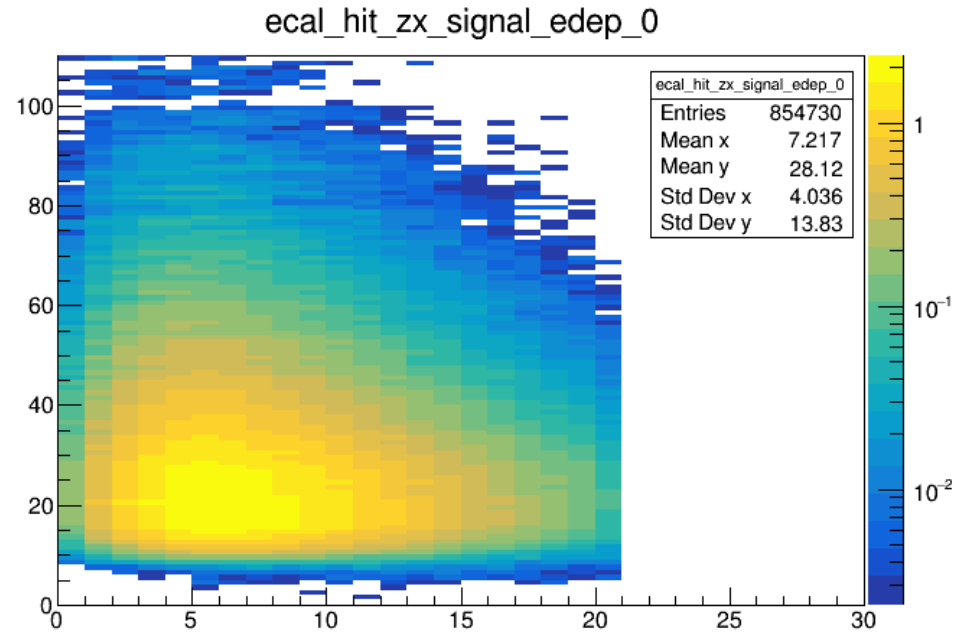
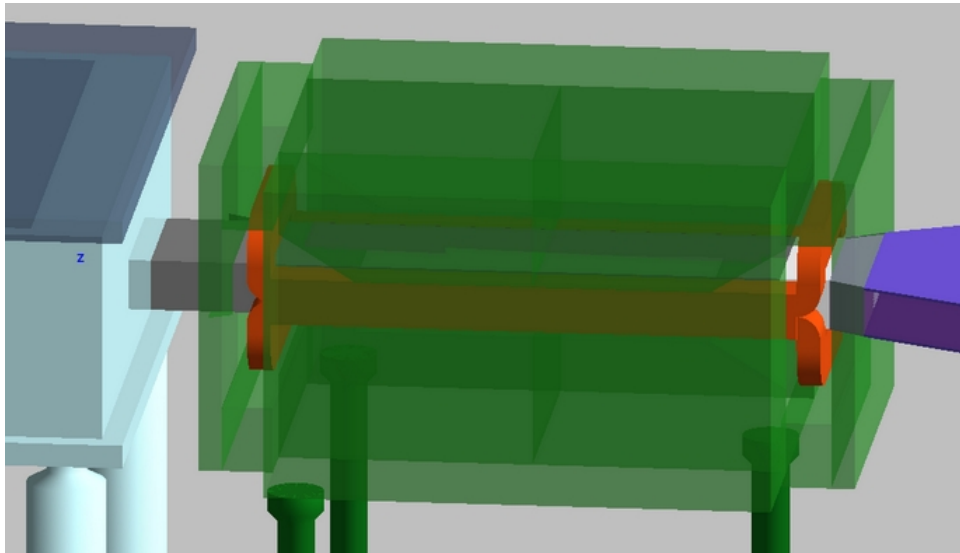

BPPP ECal signal, $w_0=5\mu\text{m}$ and $w_0=8\mu\text{m}$

ecal_hit_zx_signal_edep_0

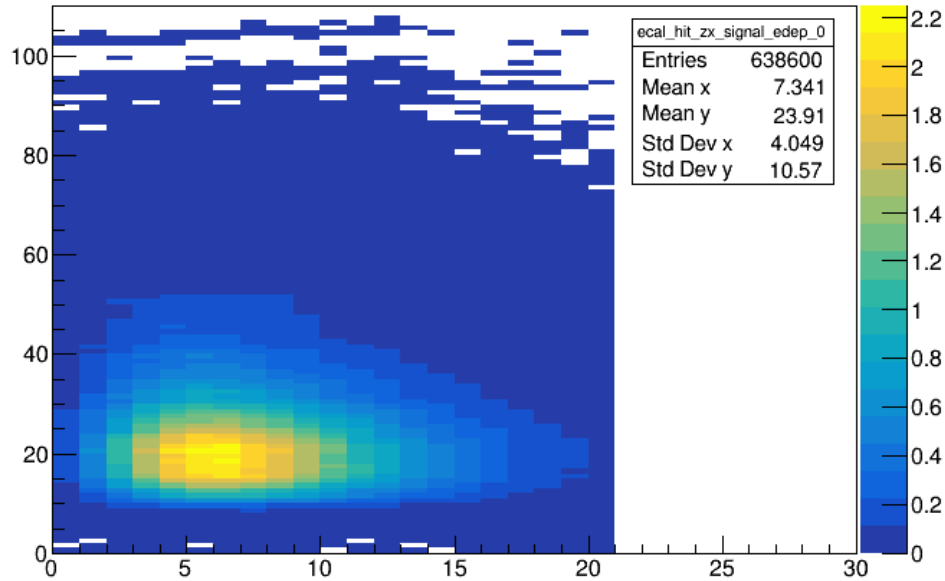

ecal_hit_zx_signal_edep_0

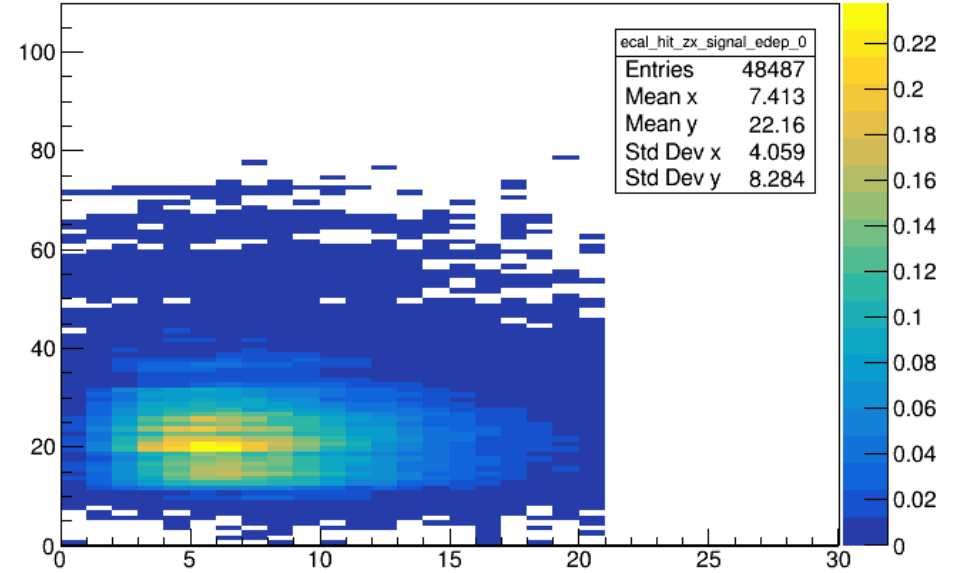

ecal_hit_zx_signal_edep_1

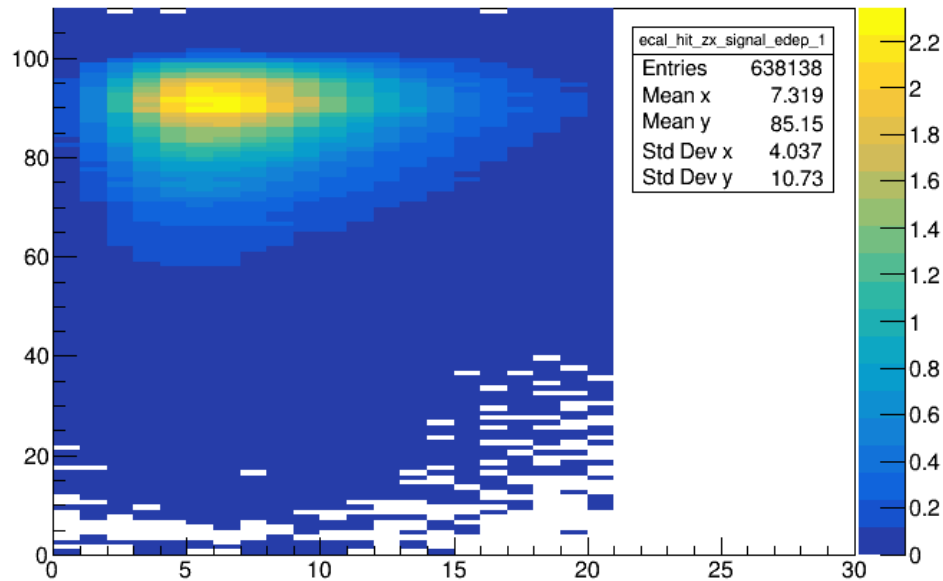

ecal_hit_zx_signal_edep_1

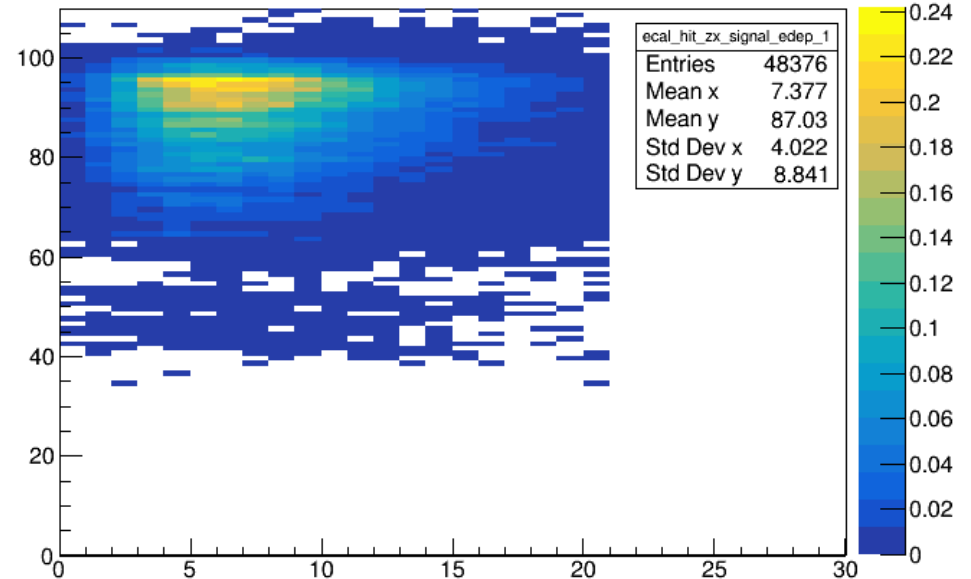

Compton photons

IPStrong and
Ptarmigan

