

ISMD 2008 Symposium, Hamburg, September 2008

Unintegrated (TMD) parton distributions and parton-shower calculations

F. Hautmann (Oxford)

- I. Motivation: multi-particle final states at the LHC
- II. Unintegrated pdf's and parton-shower Monte Carlo generators
- III. Angular and momentum correlations in multi-jet production
- IV. Summary and prospects for LHC final states

I. INTRODUCTION

Multi-scale hard processes at high-energy hadron colliders:

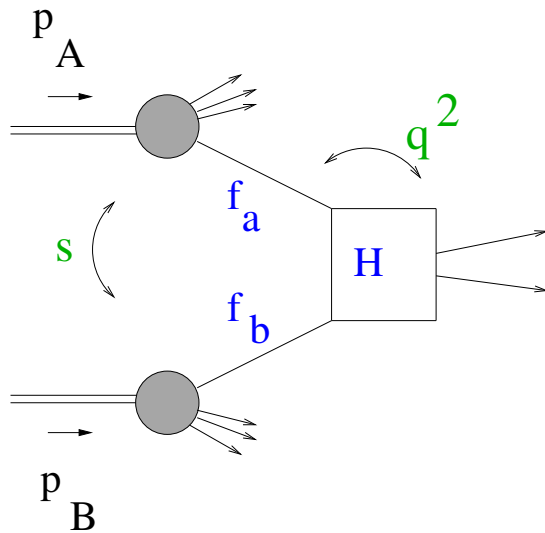

$$\sigma = \int f_{a/A} \otimes f_{b/B} \otimes H_{ab}$$

phase space opening up for large \sqrt{s}



- large number of events with **multiple** hard scales: q_1^2, \dots, q_n^2
- potentially large corrections to all orders in α_s , $\sim \ln^k(q_i^2/q_j^2)$
- parton distributions probed near kinematic boundaries $x \rightarrow 0, 1 - x \rightarrow 0$

▷ Part of the effects are universal

↪ ex.: high-order corrections in renormalization group evolution

$$\mu \frac{d}{d\mu} f = \gamma \otimes f$$

$$\gamma \simeq \gamma^{(LO)} (1 + c_1 \alpha_s + \dots + c_{n+m} \alpha_s^m (\alpha_s L)^n + \dots) , L = \text{“large log”}$$

▷ Part of them are not universal (final-state correlations, exclusive variables, ...)

↪ yet can be summed by techniques that generalize RG factorization

- pdf's unintegrated in both \parallel and \perp components (TMD pdf)

Examples:

- Sudakov processes
- small-x physics
- reconstruction of fully exclusive final states by Monte-Carlos

- perturbative calculations at fixed order (NLO, multi-leg)

Multi-particle final states:

(t , b , jets, heavy bosons, ...)

- parton-shower event simulation (higher orders, hadronization)

Multiple

Finite transverse-momentum tail in initial-state radiative processes

\implies

important for $x \rightarrow 0$ (high-energy region)

$x \rightarrow 1$ (Sudakov region)

hard scales

↓

- included partially, order-by-order, in perturbative calculations (higher loops)
- amounts to corrections to the angular ordering in standard parton showers
(HERWIG, PYTHIA)

◇ inclusive cross sections: NLO (+ standard shower) probably sufficient

◇ correlations, exclusive final-state structure?

Multiple QCD radiation by parton showers (space-like case)

◇ Collinear (incoherent) emission:



◇ Soft-gluon emission \rightarrow ordering in decay angles (color coherence for $x \sim 1$)

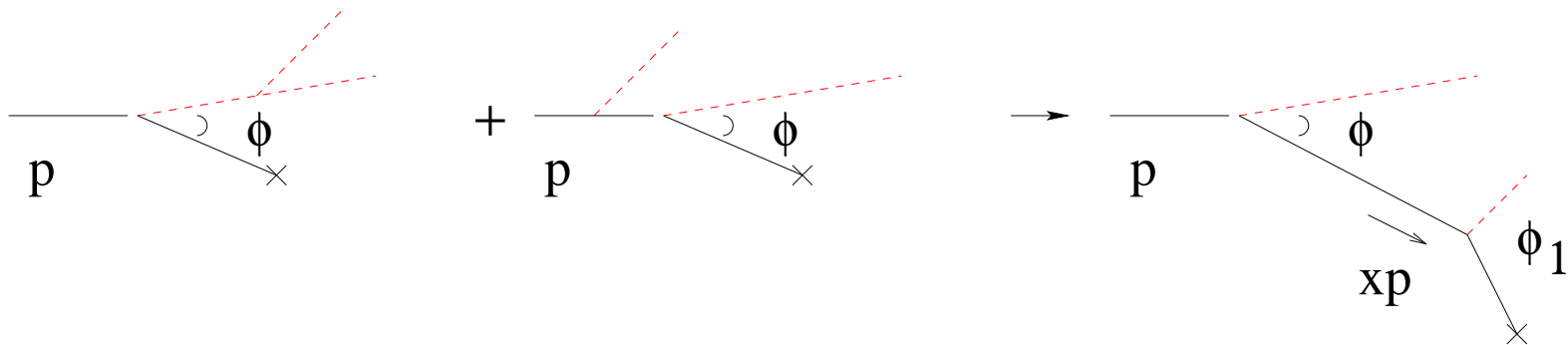

▷ implemented in HERWIG, new PYTHIA
(note: ang. ordering \approx k_{\perp} -ordering for small x)

◇ Coherent radiation at $x \ll 1 \Rightarrow$ corrections to angular ordering:

▷ MC based on k_{\perp} -dependent unintegrated pdfs and MEs

II. UNINTEGRATED PDF'S AND PARTON SHOWERS

How to characterize u-pdf gauge-invariantly?

Example 1: Unintegrated (TMD) pdf from high energy factorization:

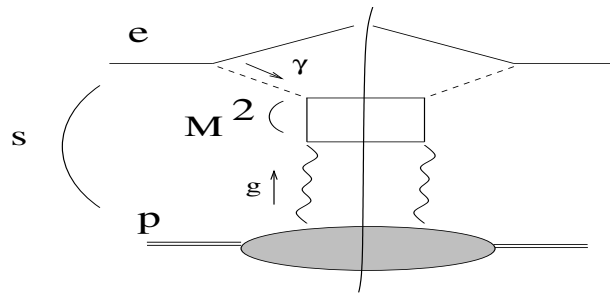

◇ single gluon polarization dominates $s \gg M^2 \gg \Lambda_{\text{QCD}}^2$

↪ gauge invariance rescued (despite gluon off-shell)

[Ciafaloni; Catani, Hautmann; ...]

◇ energy evolution equations / corrections down by $1/\ln s$ rather than $1/Q$

↪ BFKL (+ its variants)

◇ Note: can match on to arbitrarily high k_{\perp} in the UV \Rightarrow

- suitable for simulations of jet physics at the LHC
- well-defined summation of higher-order radiative corrections

◇ Gauge-invariant characterization over **whole** phase space is more difficult

Example 2: Generalize ordinary (lightcone) pdf to non-lightlike distances:

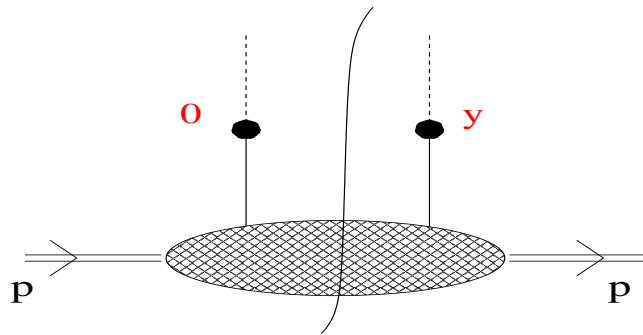

$$\mathbf{p} = (p^+, m^2 / 2 p^+, \mathbf{0}_\perp)$$

$$\tilde{f}(y) = \langle P | \bar{\psi}(y) V_y^\dagger(n) \gamma^+ V_0(n) \psi(0) | P \rangle, \quad y = (0, y^-, y_\perp)$$

$$V_y(n) = \mathcal{P} \exp \left(i g_s \int_0^\infty d\tau n \cdot A(y + \tau n) \right) \quad \text{eikonal Wilson line in direction } n$$

- works at tree level [Mulders, 2002; Belitsky et al., 2003; ...]
- subtler at level of radiative corrections [Collins; Hautmann; Rogers; Cherednikov, ...
 \hookrightarrow endpoint $x \rightarrow 1$ behavior
- spectator interactions possibly non-decoupling (non-abelian Coulomb phase)
 [Mulders, Bomhof; Collins, Qiu; Brodsky, ...]

MC GENERATORS WITH U-PDF'S

◇ All MC's based on u-pdf's rely on high-energy factorization to

a) generate hard-scattering event (hard ME)

b) couple it to initial-state shower

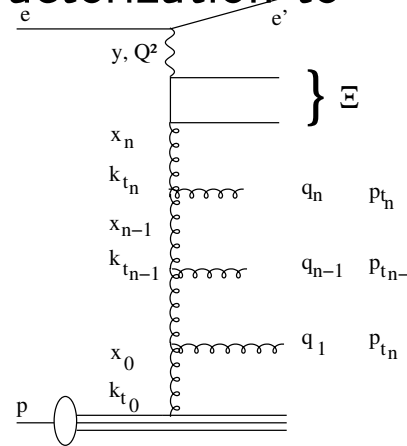

(a)

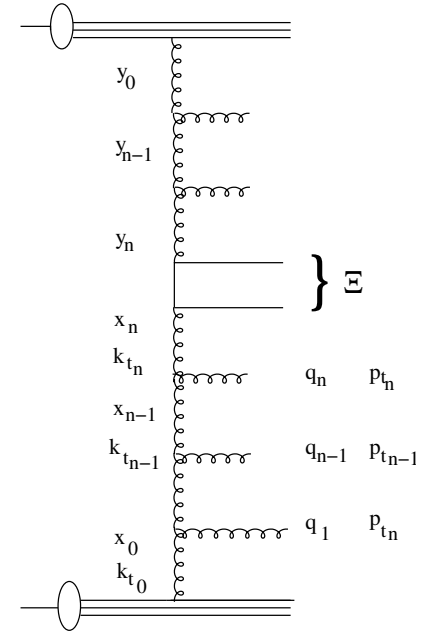

(b)

◇ differ by detailed model for initial state

[reviewed in J.R. Andersen et al. (2006); B. Andersson et al. (2002)]

- all implement correct $\alpha_s^n x^{-1} \ln^{n-1} x$ behavior for spacelike evolution at $x \ll 1$ to all orders in α_s

$$\exp \int (dk^2/k^2) \gamma(\alpha_s(k^2))$$

- resum non-universal $\alpha_s^k \ln^k(s/p_\perp^2)$ (in certain cases)
- non-leading contributions possibly important for final states

Basic ingredients in k_{\perp} -dependent parton showers

- ME by perturbative computation; u-pdf fit from data

Jung, Salam, Ciafaloni,

Catani, Hautmann, Marchesini, Webber, ...

• branching eq. : $\mathcal{A}(x, k_T, \mu) = \mathcal{A}_0(x, k_T, \mu) + \int \frac{dz}{z} \int \frac{dq^2}{q^2} \Theta(\mu - zq)$

$$\times \underbrace{\Delta(\mu, zq)}_{\text{Sudakov}} \underbrace{\mathcal{P}(z, q, k_T)}_{\text{unintegr. splitting}} \mathcal{A}\left(\frac{x}{z}, k_T + (1-z)q, q\right)$$

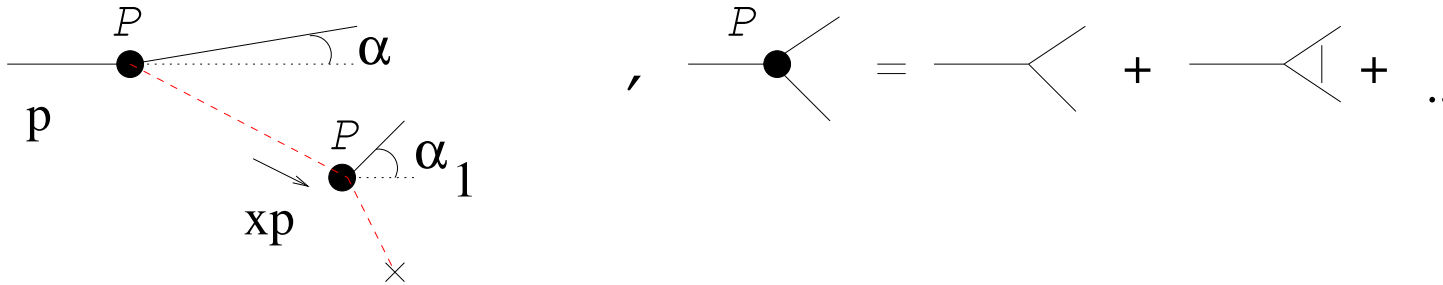

(left) Coherent radiation in the space-like parton shower for $x \ll 1$;

(right) the unintegrated splitting function \mathcal{P} , including small- x virtual corrections.

$$\alpha/x > \alpha_1 > \alpha \quad (\text{small-}x \text{ coherence region})$$

Implementations:

Höche, Krauss and Teubner, arXiv:0705.4577	(KMR)
Golec, Jadach, Placzek, Stephens, Skrzypek, hep-ph/0703317	(CCFM)
LDCMC	Lönnblad & Sjö Dahl, 2005; Gustafson, Lönnblad & Miu, 2002 (LDC)
CASCADE	Jung, 2004, 2002; Jung and Salam, 2001 (CCFM)
SMALLX	Marchesini & Webber, 1992 (CCFM)

Advantages over standard Monte-Carlo like PYTHIA or HERWIG:

- better treatment of high-energy logarithmic effects
- likely more suitable for simulating underlying event's k_{\perp}

Current limitations:

- radiative terms associated to $x \sim 1$ not automatically included
- procedure to correct for this not yet systematic
 - ↔ e.g.: LO-DGLAP in Höche et al
- quark contributions in initial state included partially
 - ↔ see also: k_{\perp} kernel for sea-quark evolution [Catani & H]
- limited knowledge of u-pdf's [Jung et al., arXiv:0706.3793; J. R. Andersen et al., 2006]

III. MULTI-JET CORRELATIONS

- sensitive probes of QCD multiple-radiation effects

Ex.: azimuthal $\Delta\phi$ correlation (between two hardest jets)

- Tevatron $\Delta\phi$ well described by HERWIG
- used for MC parameter tuning in PYTHIA

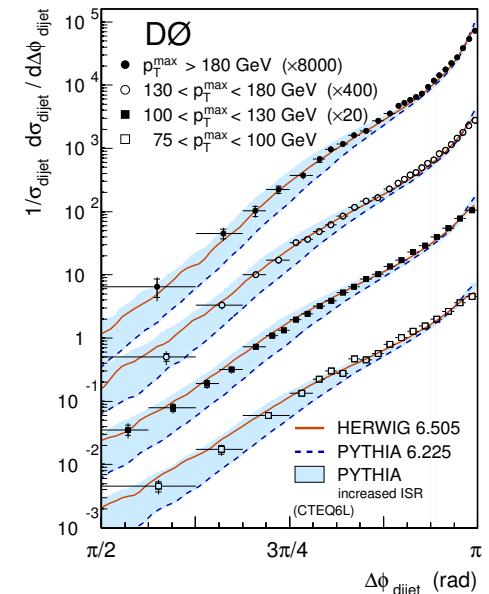

- HERA $\Delta\phi$ not well described by standard MC

↪ see below

- accessible at the LHC relatively early

↪ probe coherence effects in high-energy spacelike showers

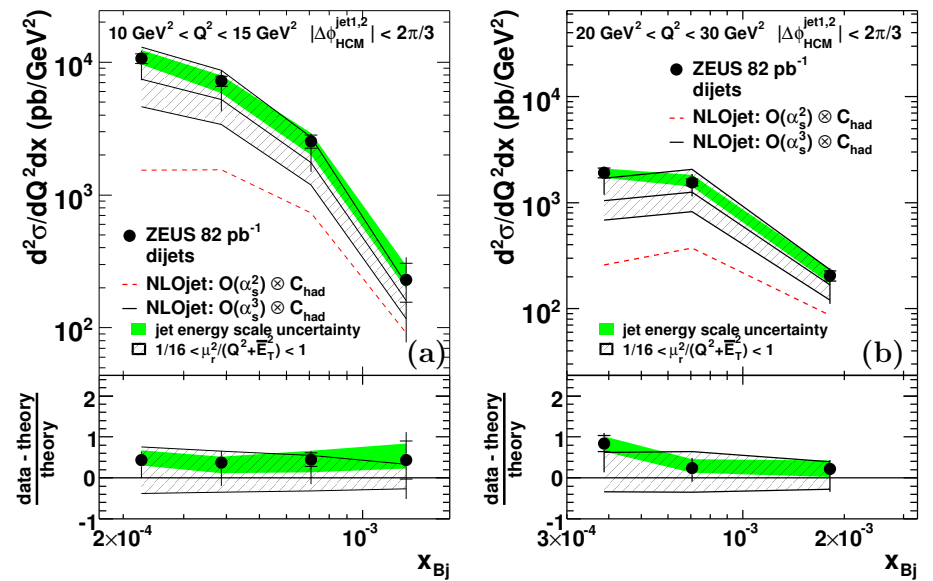
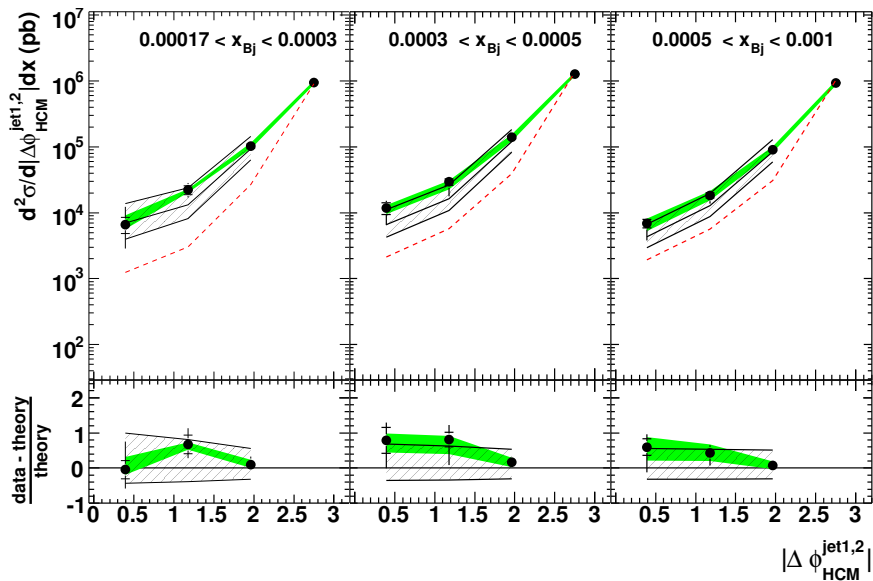

(left) Azimuth dependence and (right) Bjorken- x dependence of di-jet distributions

- measured by ZEUS [arXiv:0705.1931]
- compared with NLO results

$$Q^2 > 10 \text{ GeV}^2 \quad , \quad 10^{-4} < x < 10^{-2}$$

◇ large variation from order- α_s^2 to order- α_s^3 prediction as $\Delta\phi$ and x decrease
 \Rightarrow sizeable theory uncertainty at NLO (underestimated by “ μ error band”)

Angular jet correlations from k_{\perp} -shower CASCADE and from HERWIG

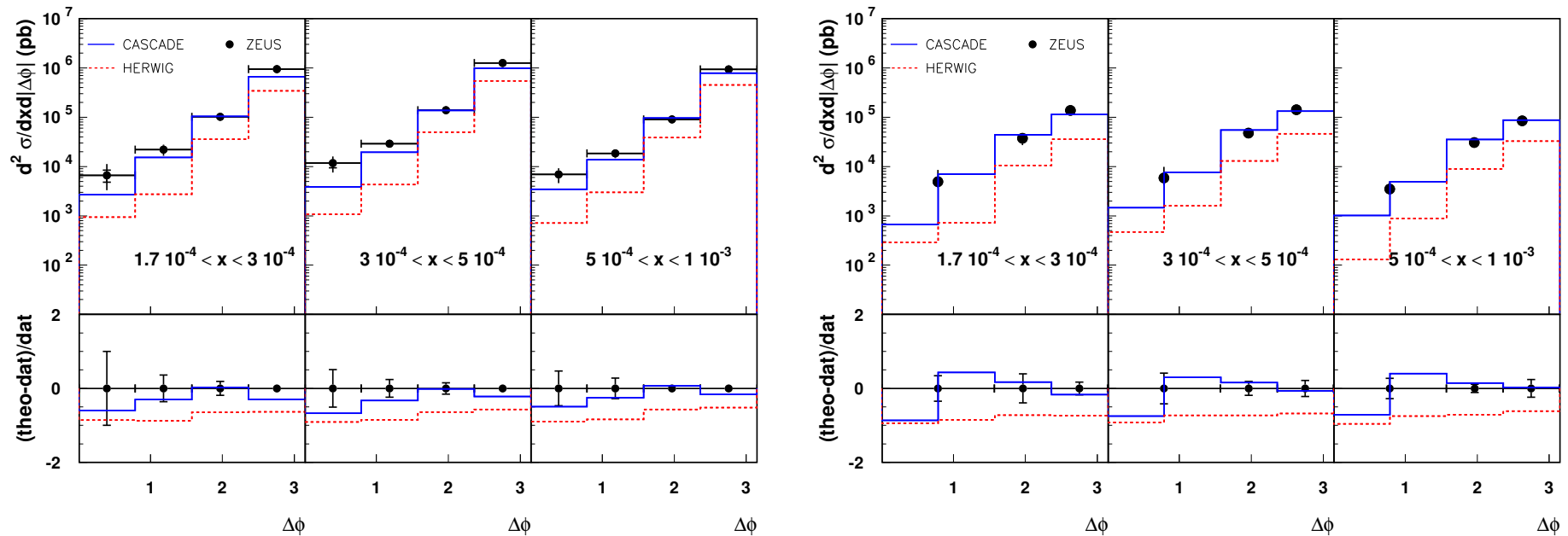

(left) di-jet cross section; (right) three-jet cross section

Jung & H, arXiv:0712.0568 [hep-ph]

- different shapes from the two MC
 - largest differences at small $\Delta\phi$
- good description of measurement by CASCADE

AZIMUTHAL DISTRIBUTION OF THE THIRD JET

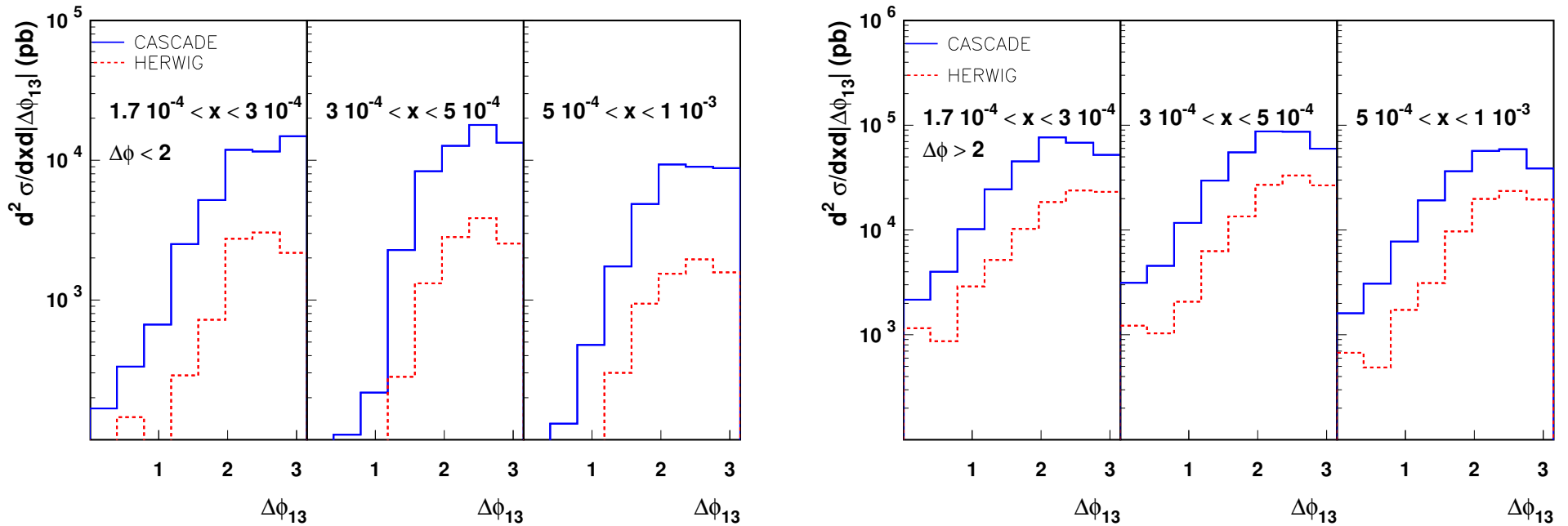

Cross section in the azimuthal angle between the hardest and the third jet for small (left) and large (right) azimuthal separations between the leading jets

Jung & H, arXiv:0712.0568 [hep-ph]

- small $\Delta\phi \Rightarrow$ non-negligible initial $k_{\perp} \Rightarrow$ larger corrections to collinear ordering
 - curves become closer at large $\Delta\phi$

MOMENTUM CORRELATIONS

[Jung & H, arXiv:0805.1049]

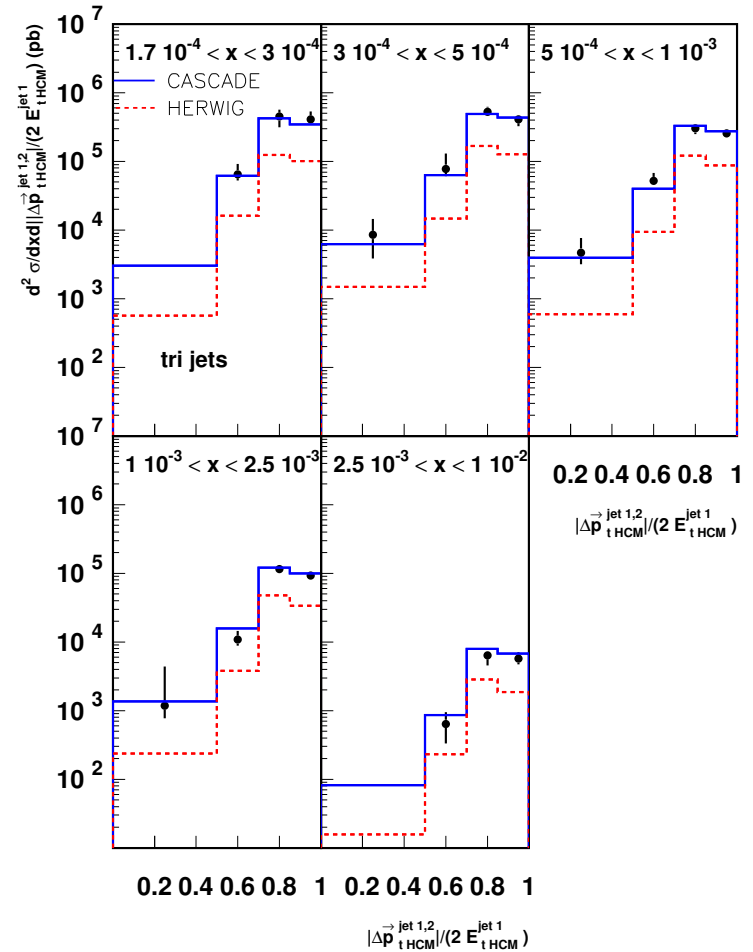
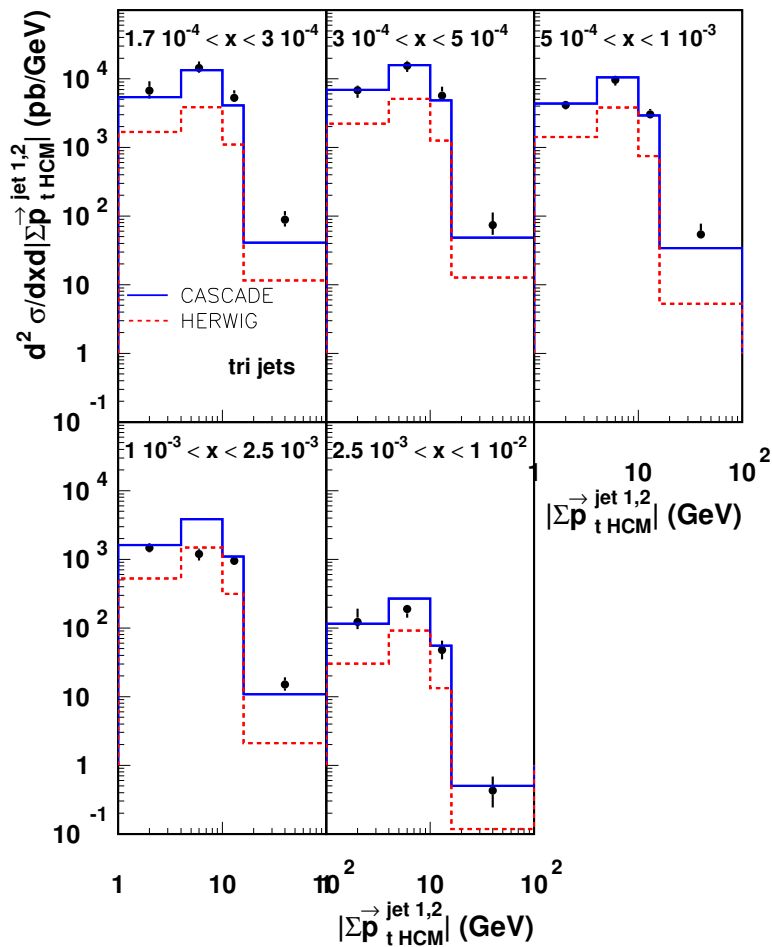

- correlations in the transverse momentum imbalance between the leading jets

Normalize to the back-to-back cross section:

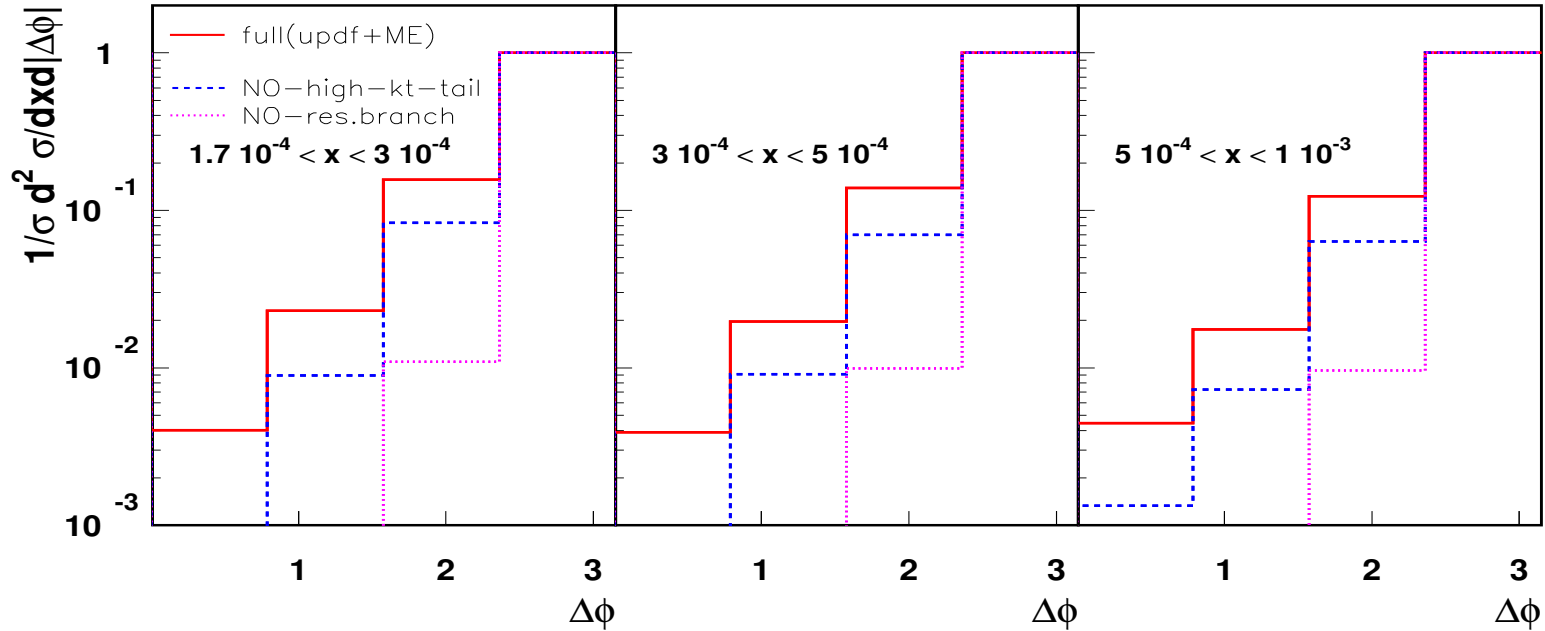

— updf \oplus ME

- - - updf \oplus ME_{collin.} : $\mathcal{M} \rightarrow \mathcal{M}_{collin.}(k_T) = \mathcal{M}(0_\perp) \Theta(\mu - k_T)$

..... no resolved branching : $\mathcal{A} \rightarrow \mathcal{A}_{no-res.}(x, k_T, \mu) = \mathcal{A}_0(x, k_T, Q_0) \Delta(\mu, Q_0)$

▷ high- k_\perp component in ME essential to describe correlation at small $\Delta\phi$

▷ k_\perp -dependence in u-pdf alone not sufficient

(cfr., e.g., MC by Höche, Krauss & Teubner, arXiv:0705.4577:

u-pdf but no ME correction)

Summary on 3-jet

▷ U-pdfs \oplus k_{\perp} -dependent hard MEs describe multi-jet measurements including correlations.

▷ coherence effects in angular distributions non-negligible at high energy (small x) and small $\Delta\phi$

(near large $\Delta\phi$, Coulomb/radiative mixed terms also possibly relevant)

▷ Furthermore:

- Results similar to HERWIG if reduced to k_{\perp} -ordered phase space

- Similar to fixed NLO where corrections are not large

▷ Non-forward jets \Rightarrow results less dependent on details of u-pdf evolution models

IV. Prospects for LHC final states and conclusions

◇ Physics in the forward region at the LHC:

- sensitive to u-pdf evolution
- better understanding of u-pdf needed for target fragmentation region
[e.g.: Trentadue et al, in progress]

◇ MC and radiative corrections to gluon fusion processes:

- production of b, c — what size NLO uncertainties at LHC energies?
[see MC@NLO; Nason et al.]
 - sizeable corrections from $g \rightarrow b\bar{b}$ coupling to spacelike jet
 - multi-scale effects in $b\bar{b} + W/Z$ production
 - k_{\perp} -shower vs. MC@NLO for top-antitop pair production
(↔ see p_T spectrum)
- final states with Higgs
 - possibly 10 ÷ 20 % effects in p_t spectrum from $x \ll 1$ terms?
[Kulesza, Sterman & Vogelsang, 2004]

p_T distribution of $t\bar{t}$ pairs

from the k_{\perp} -shower *CASCADE* and from MC@NLO at LHC energies

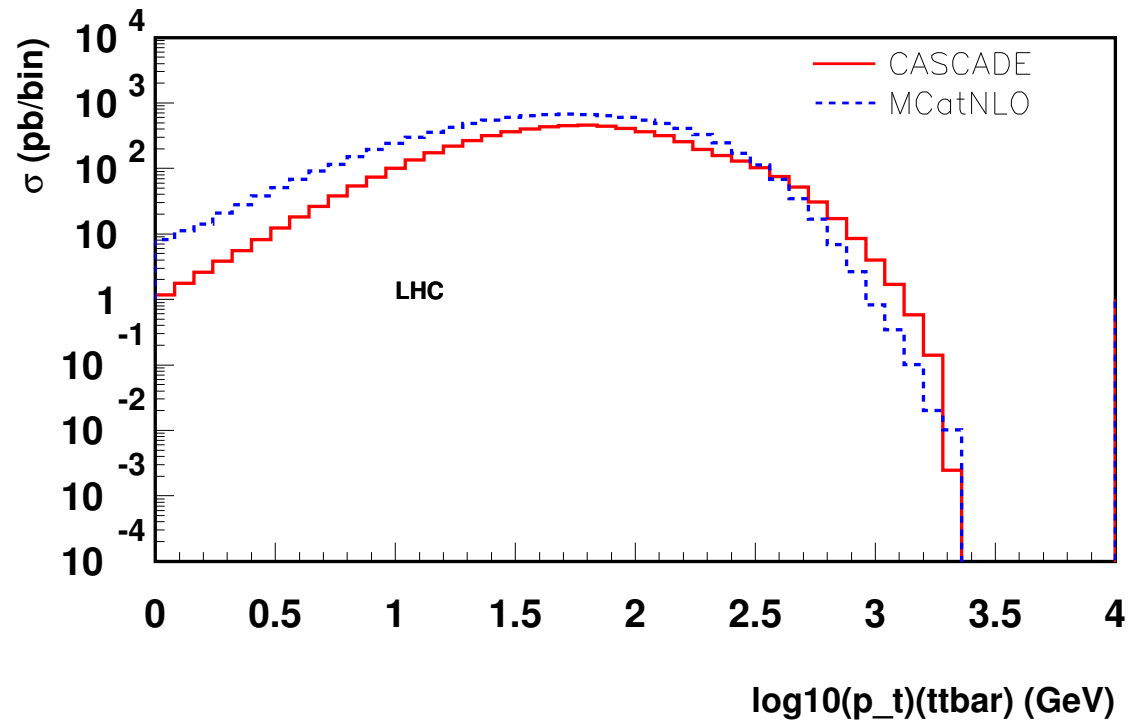

ISSUES AT HIGHER ORDER

- u-pdf defined gauge-invariantly for small x by high-energy factorization
- general definitions including $x \sim 1$?

Collins, Rogers and Stasto, arXiv:0708.2833
H, PLB 655 (2007) [hep-ph/0702196]

- dijet back-to-back region

→ possible factorization-breaking from soft gluon exchange in pp?

Mulders, Bomhof, Collins,
Vogelsang, Qiu, Yuan, Pijlman, ...
2006-2008

◇ appears at $N^3\text{LO}$ (2 soft, 1 collinear partons)

◇ does it survive destructive interference from multiple emission?

- Note: Coulomb/radiative mixing terms also appear to break angular ordering in di-jet cross sections with gap in rapidity

Forshaw, Kyrielleis & Seymour, JHEP 08 (2006)

Conclusions

- When the LHC turns on, realistic Monte-Carlo are needed to analyze complex multi-particle final states with many hard scales
 - Branching methods based on u-pdfs and k_{\perp} -MEs useful to
 - ▷ simulate high-energy parton showers
 - ▷ investigate possibly new effects from QCD physics
 - Systematic theoretical studies of u-pdf's ongoing
 - ▷ relevant to turn these Monte-Carlo's into general-purpose tools

EXTRA SLIDES

azimuthal distribution in 3-jet cross section [Zeus, 2007]

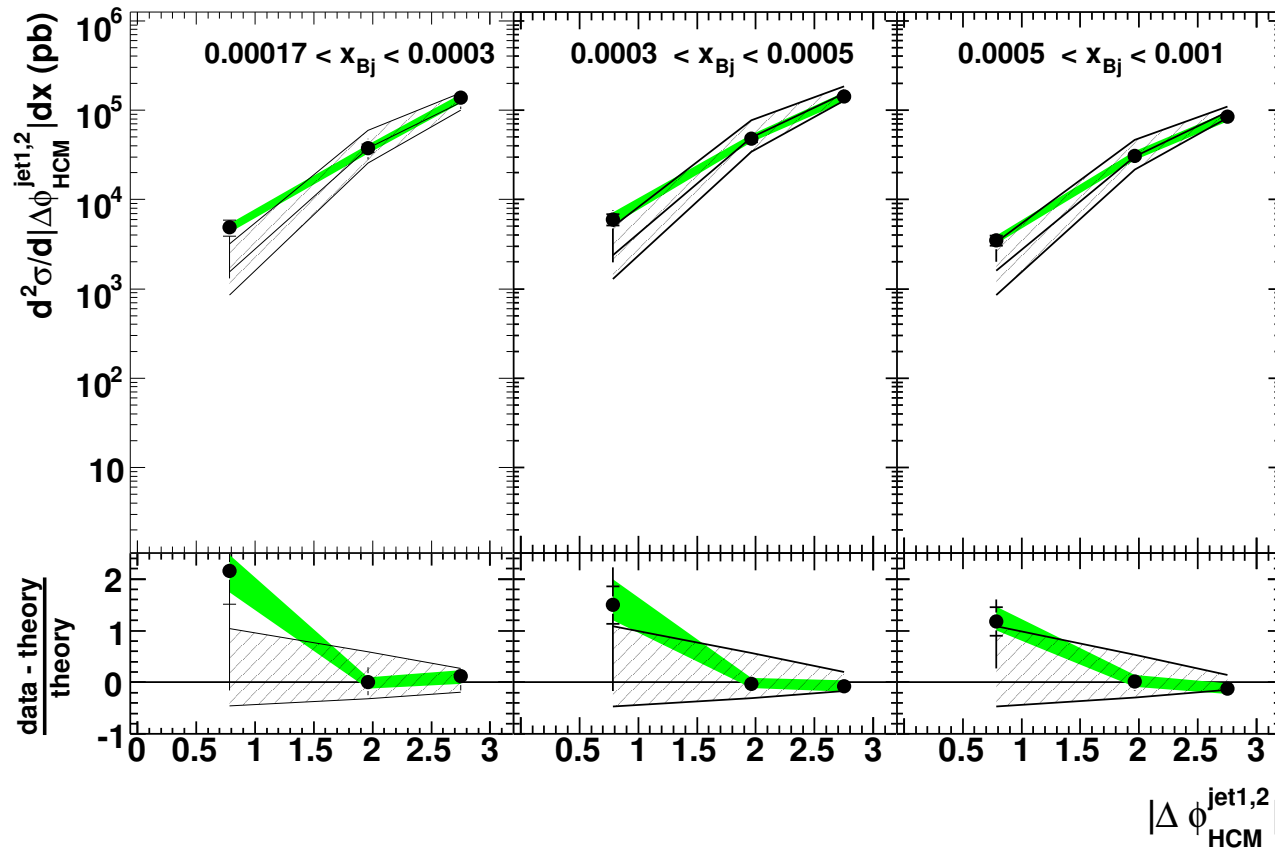

- besides angular correlations, sizeable NLO uncertainties in other associated distributions
- NLO results are much more stable for inclusive jet cross sections

$$E_{T,HCM}^{\text{jet}-1} > 7 \text{ GeV} \quad , \quad E_{T,HCM}^{\text{jet}-2,3} > 5 \text{ GeV} \quad , \quad -1 < \eta_{lab} < 2.5$$

- Jet clustering and hadronization:

- ▷ moderate hadronization corrections from jet algorithm used by Zeus and H1
[arXiv:0705.1931 [hep-ex]; hep-ex/0310019]

- ▷ jet clustering free of non-global logarithms

- [Dasgupta et al., hep-ph/0610242]

- ▷ asymmetric jet cuts to avoid double logs in minimum p_T

- [Banfi and Dasgupta, hep-ph/0312108]

- ▷ nonperturbative corrections in inverse powers of Q moderate for $Q^2 > 10\text{GeV}^2$

- Radiative effects at higher order:

- ◇ fixed-order beyond NLO is outside present reach for multi-jets in ep and pp

- ◇ enhanced (soft/collinear) higher orders from near back-to-back region

- Y.Delenda et al., arXiv:0706.2172; arXiv:0804.3786; HERWIG

- ◇ largest effects seen at small $\Delta\phi$ (3 well-separated hard jets)

Example: the CASCADE Monte-Carlo

U-pdf fits \oplus evolution

[Hansson & Jung, 2007]

[\hookrightarrow DIS, jets, heavy flavors]

$$x\mathcal{A}_0(x, k_T, Q_0) = A x^{-B} (1-x)^C \exp\left[-(k_T - \lambda)^2/\nu^2\right]$$

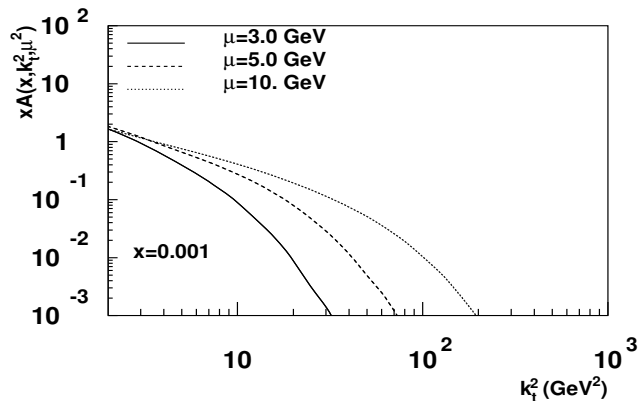
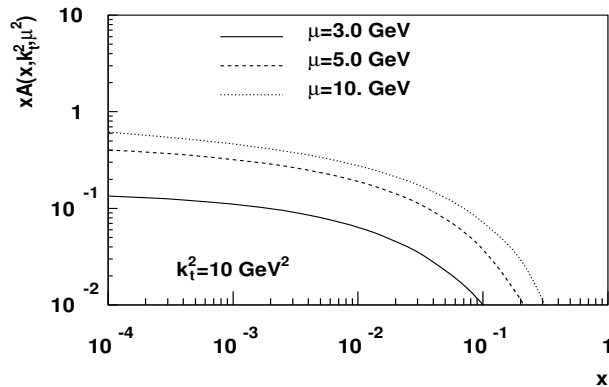

$Q_0 = 1.1 \text{ GeV}$				
A	B	C	λ	ν
0.4695	0.025	4.0	1.5 GeV	1.06 GeV

JET MULTIPLICITIES

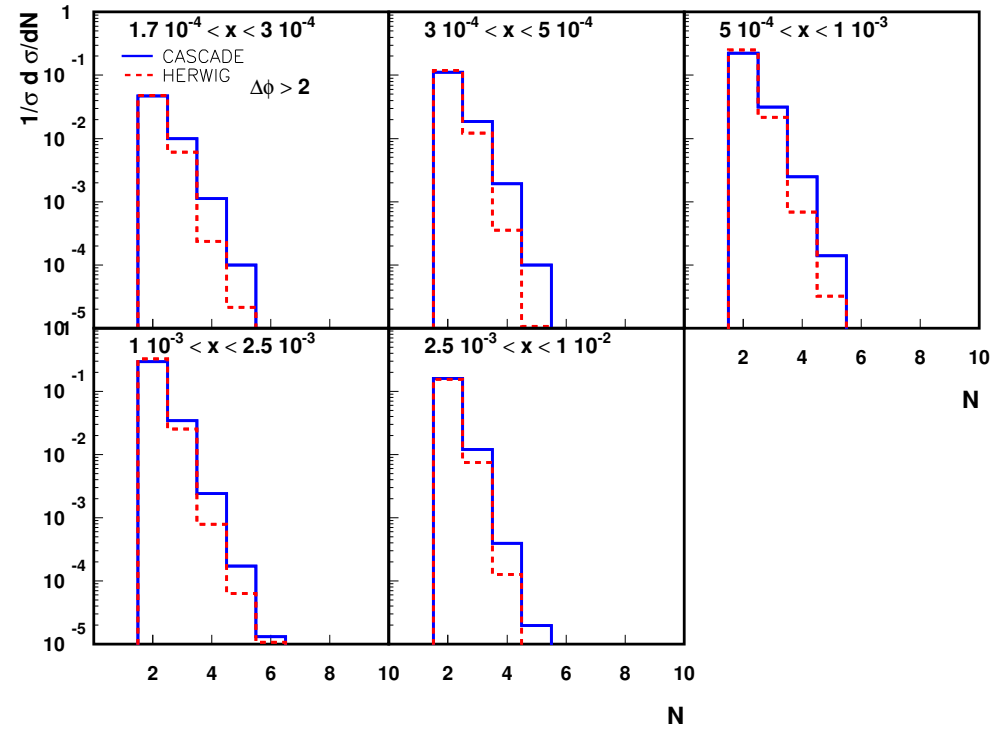
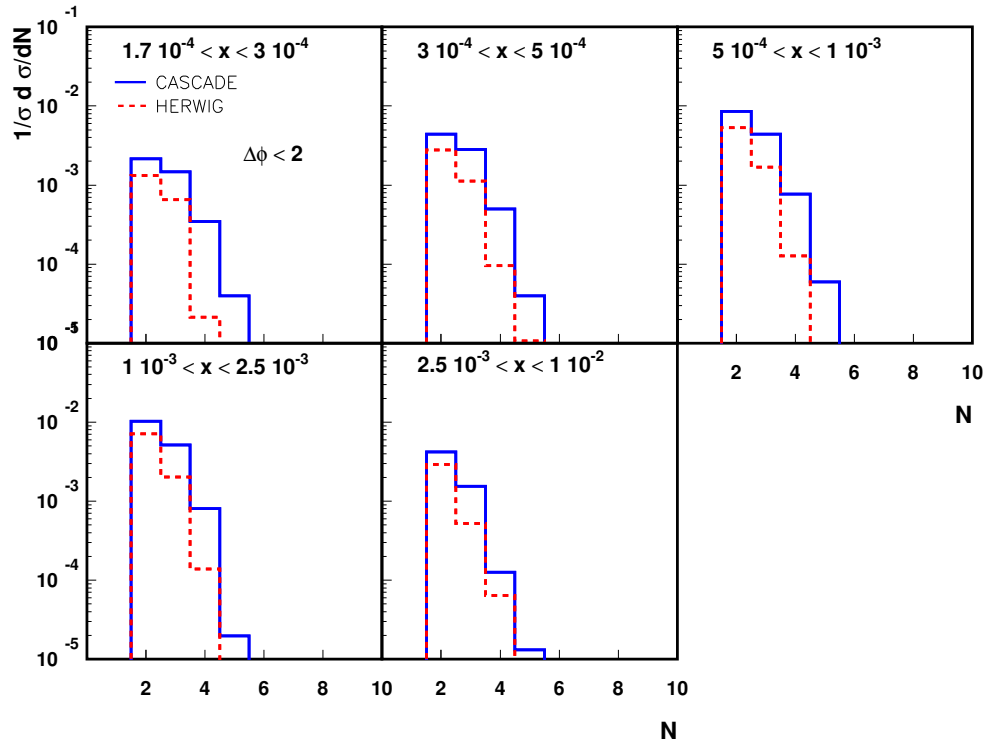

(left) $\Delta\phi < 2$; (right) $\Delta\phi > 2$

[Jung & H, arXiv:0805.1049]

- larger contribution from high multiplicity in the MC with u-pdf

ENDPOINT $x \rightarrow 1$ BEHAVIOR:

$$n = (0, 1, 0_{\perp})$$

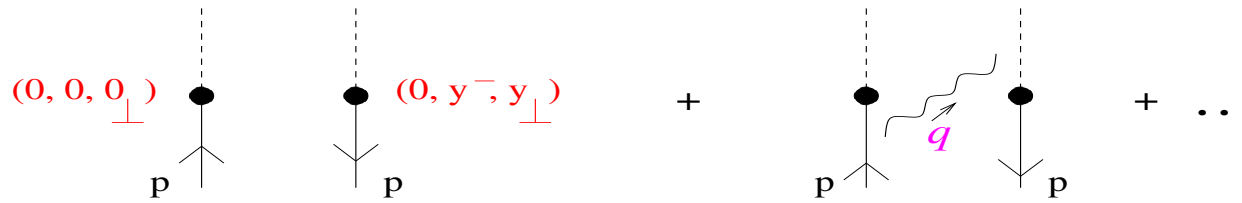

$$f_{(1)} = P_R(x, k_{\perp}) - \delta(1-x) \delta(k_{\perp}) \int dx' dk'_{\perp} P_R(x', k'_{\perp})$$

where
$$P_R = \frac{\alpha_s C_F}{\pi^2} \left[\frac{1}{1-x} \frac{1}{k_{\perp}^2 + \rho^2} + \{\text{regular at } x \rightarrow 1\} \right]$$
 $\rho = \text{IR regulator}$

$\underbrace{\hspace{10em}}_{\text{endpoint singularity}} \quad (q^+ \rightarrow 0, \forall k_{\perp})$

[Collins, 2003]

◇ Physical observables:

$$\begin{aligned} \mathcal{O} &= \int dx dk_{\perp} f_{(1)}(x, k_{\perp}) \varphi(x, k_{\perp}) \\ &= \int dx dk_{\perp} [\varphi(x, k_{\perp}) - \varphi(1, 0_{\perp})] P_R(x, k_{\perp}) \end{aligned}$$

inclusive case: φ independent of $k_{\perp} \Rightarrow 1/(1-x)_+$ from real + virtual

general case: endpoint divergences (incomplete KLN cancellation)

CUT-OFF REGULARIZATION

▷ cut-off in Monte-Carlo generators using u-pdf's

CASCADE www.desy.de/~jung/cascade

SMALLX Marchesini & Webber, 90's

LDCMC www.thep.lu.se/~leif/ariadne

▷ cut-off from gauge link in non-lightlike direction n :

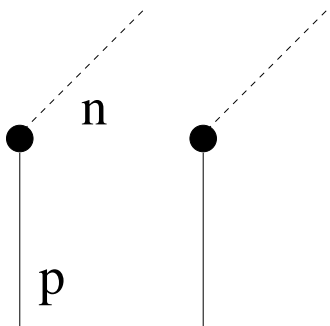

$$\eta = (\mathbf{p} \cdot \mathbf{n})^2 / n^2$$

Collins, Rogers & Stasto, arXiv:0708.2833

Ji, Ma & Yuan, 2005, 2006

earlier work from 80's and 90's

finite $\eta \Rightarrow$ singularity is cut off at $1 - x \gtrsim \sqrt{k_{\perp}/4\eta}$

• Note: lightcone limits $y^2 \rightarrow 0$ and $n^2 \rightarrow 0$ do not commute \Rightarrow

$$\Rightarrow \int dk_{\perp} f(x, k_{\perp}, \mu, \eta) = F(x, \mu, \eta) \neq \text{ordinary pdf}$$

UPDF'S WITH SUBTRACTIVE REGULARIZATION

- Endpoint divergences $x \rightarrow 1$ from incomplete KLN cancellation

Subtractive method: more systematic than cut-off. Widely used in NLO calculations.

Formulation suitable for eikonal-operator matrix elements: Collins & H, 2001.

- gauge link still evaluated at n lightlike, but multiplied by “subtraction factors”

$$\tilde{f}^{(\text{subtr})}(y^-, y_\perp) = \frac{\overbrace{\langle P | \bar{\psi}(y) V_y^\dagger(n) \gamma^+ V_0(n) \psi(0) | P \rangle}^{\text{original matrix element}}}{\underbrace{\langle 0 | V_y(u) V_y^\dagger(n) V_0(n) V_0^\dagger(u) | 0 \rangle / \langle 0 | V_{\bar{y}}(u) V_{\bar{y}}^\dagger(n) V_0(n) V_0^\dagger(u) | 0 \rangle}_{\text{counterterms}}}$$

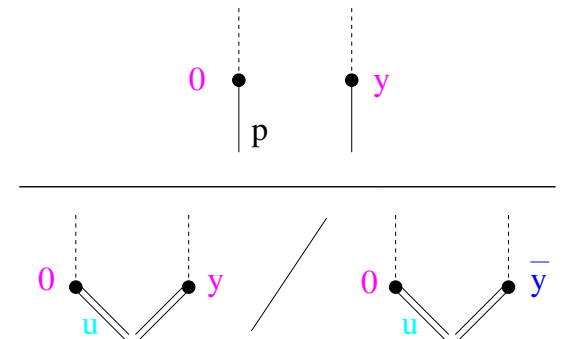

$\bar{y} = (0, y^-, 0_\perp)$; $u =$ auxiliary non-lightlike eikonal $(u^+, u^-, 0_\perp)$

H, arXiv:0708.1319

◇ u serves to regularize the endpoint; drops out of distribution integrated over k_\perp

MORE ON U-PDF'S WITH SUBTRACTIVE REGULARIZATION

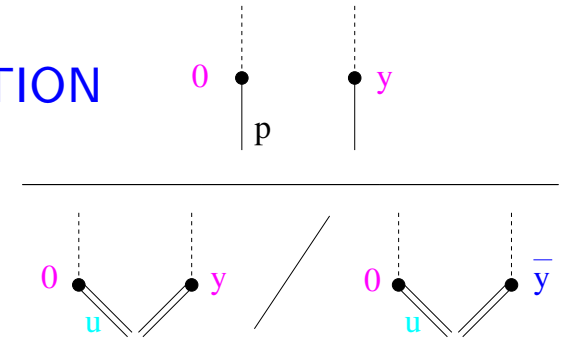

One loop expansion:

$$f_{(1)}^{(\text{subtr})}(x, k_{\perp}) = P_R(x, k_{\perp}) - \delta(1-x) \delta(k_{\perp}) \int dx' dk'_{\perp} P_R(x', k'_{\perp}) \quad (\leftarrow \text{from numerator})$$

$$- W_R(x, k_{\perp}, \zeta) + \delta(k_{\perp}) \int dk'_{\perp} W_R(x, k'_{\perp}, \zeta) \quad (\leftarrow \text{from vev's})$$

with $P_R = \alpha_s C_F / \pi^2 \left\{ 1 / [(1-x) (k_{\perp}^2 + m^2(1-x)^2)] + \dots \right\} = \text{real emission prob.}$

$W_R = \alpha_s C_F / \pi^2 \left\{ 1 / [(1-x) (k_{\perp}^2 + 4\zeta(1-x)^2)] + \dots \right\} = \text{counterterm}$

- ζ -dependence cancels upon integration in k_{\perp} [$\zeta = (p^{+2}/2)u^-/u^+$]

$$\Rightarrow \mathcal{O} = \int dx dk_{\perp} f_{(1)}^{(\text{subtr})}(x, k_{\perp}) \varphi(x, k_{\perp})$$

$$= \int dx dk_{\perp} \{ P_R [\varphi(x, 0_{\perp}) - \varphi(1, 0_{\perp})] + (P_R - W_R) [\varphi(x, k_{\perp}) - \varphi(x, 0_{\perp})] \}$$

- first term: usual $1/(1-x)_+$ distribution
- second term: singularity in P_R cancelled by W_R

Note: it works because terms in $\delta(1-x)$ cancel between the two vev's,

$$-W_R(x, k_\perp, \zeta) + \delta(1-x) \delta(k_\perp) \int dx' dk'_\perp W_R$$

and

$$+\delta(k_\perp) \int dk'_\perp W_R(x, k'_\perp, \zeta) - \delta(1-x) \delta(k_\perp) \int dx' dk'_\perp W_R .$$

- virtual correction to gauge link does not depend on y_\perp

G. Korchemsky

V. Braun et al

- ▷ subtractions have (relatively) simple form in coordinate space
- ▷ operator representation valid to all orders
- ▷ one-loop counterterm gives extension for $k_\perp \neq 0$ of the plus-distribution regularization